

A (5:1)

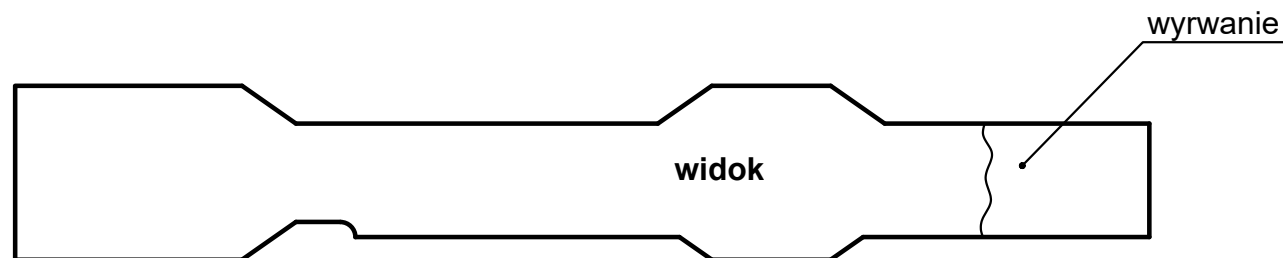

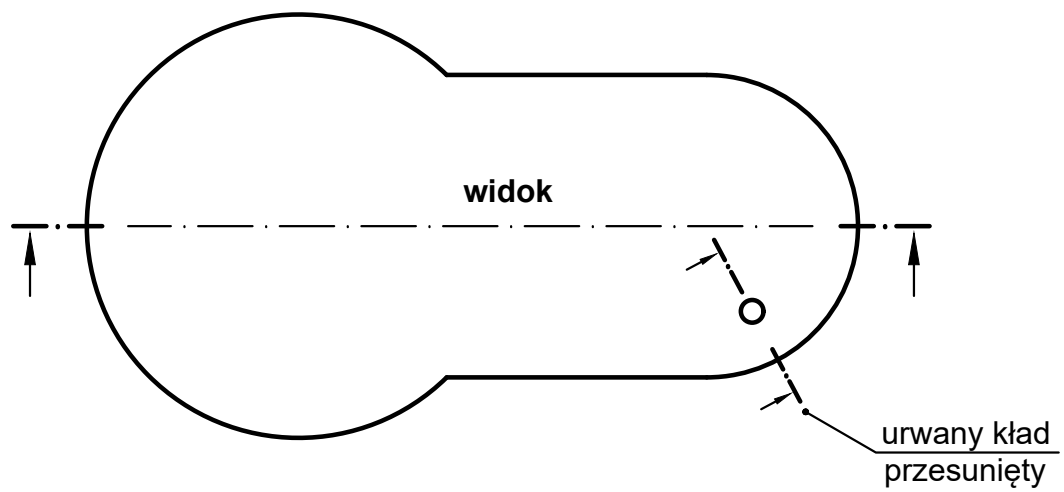

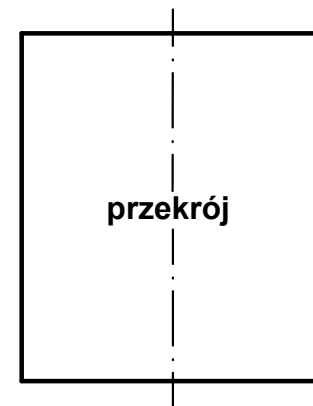

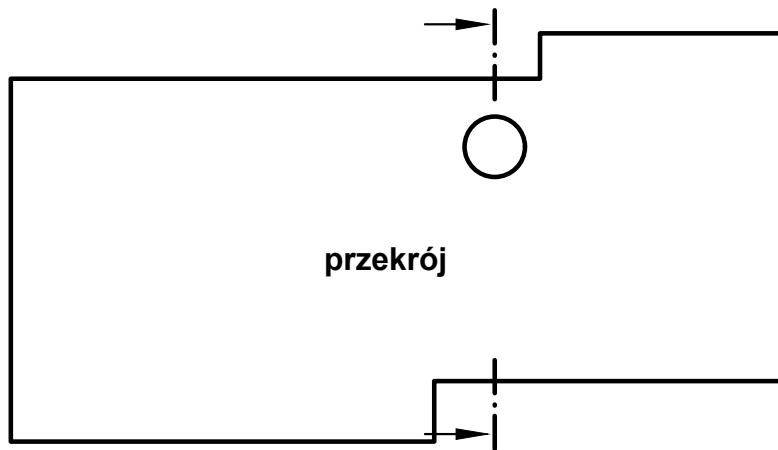
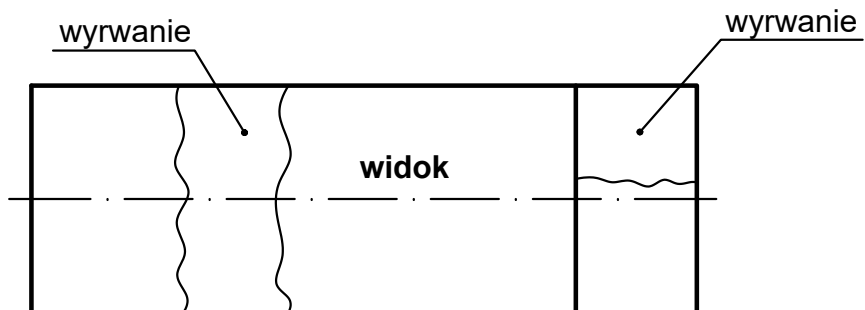
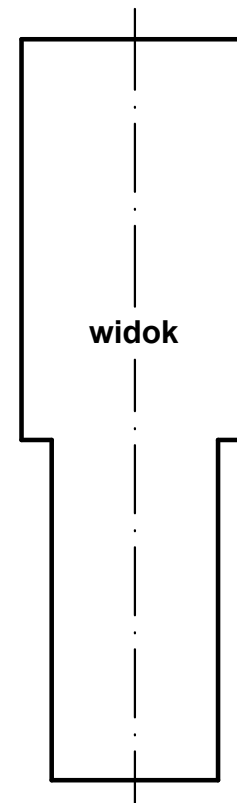
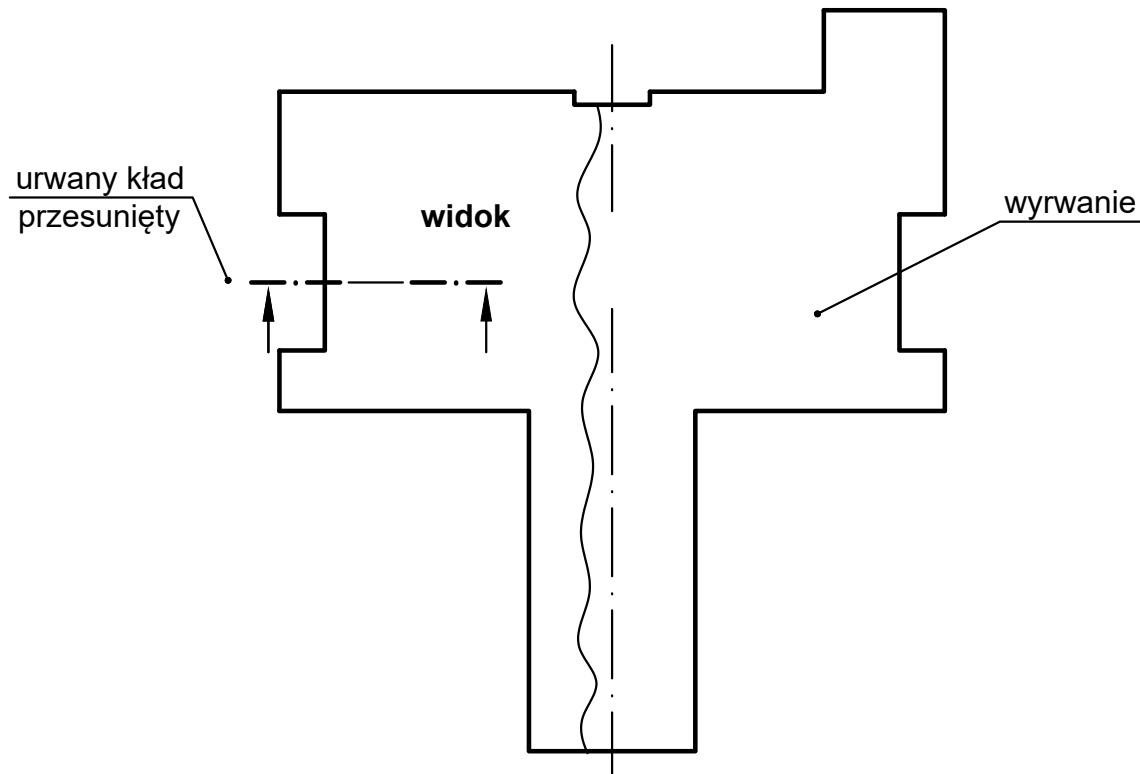
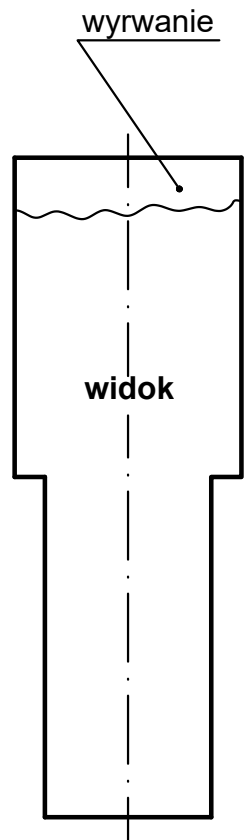
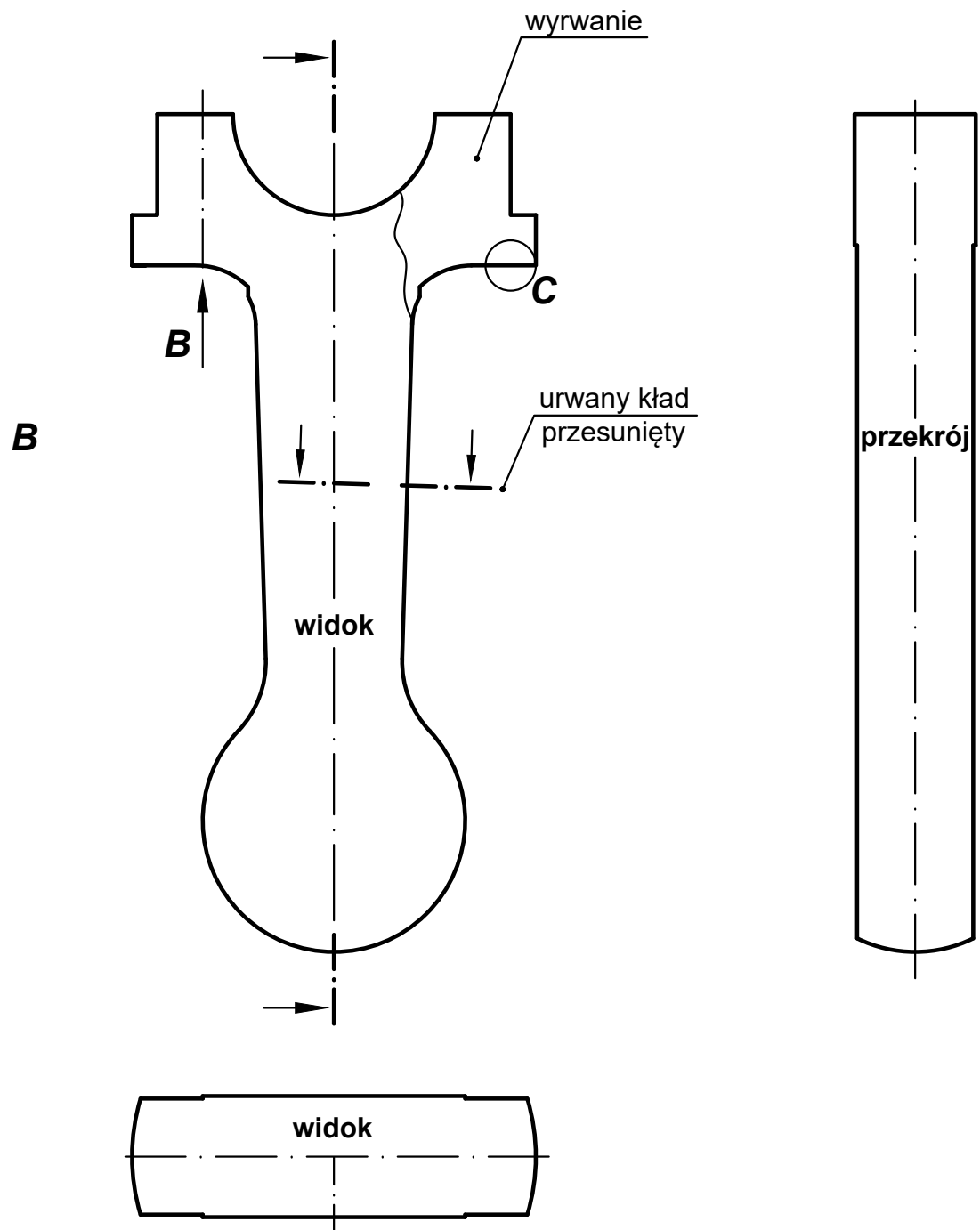

B (2:1)

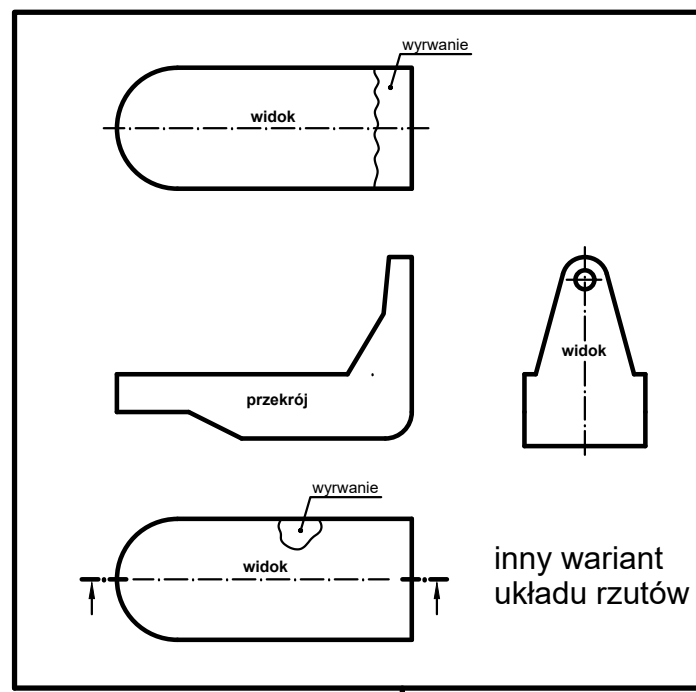
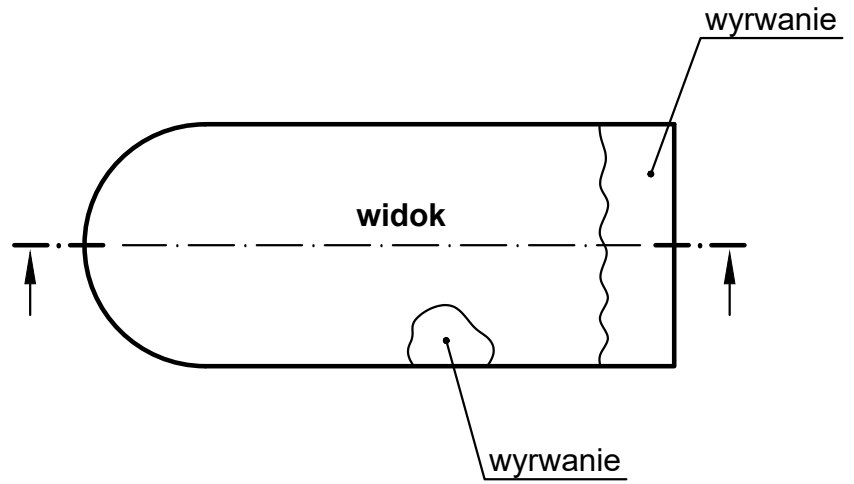
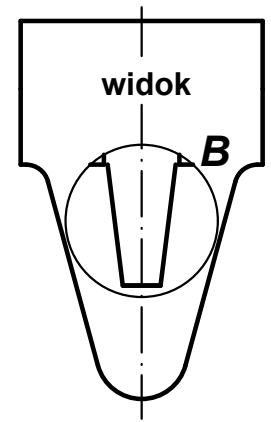
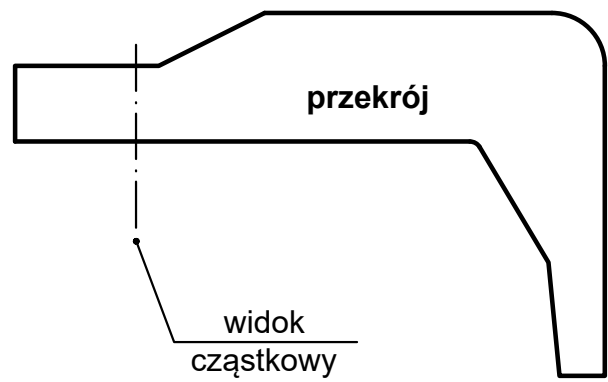

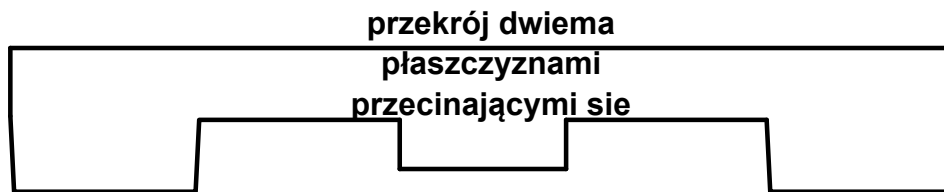
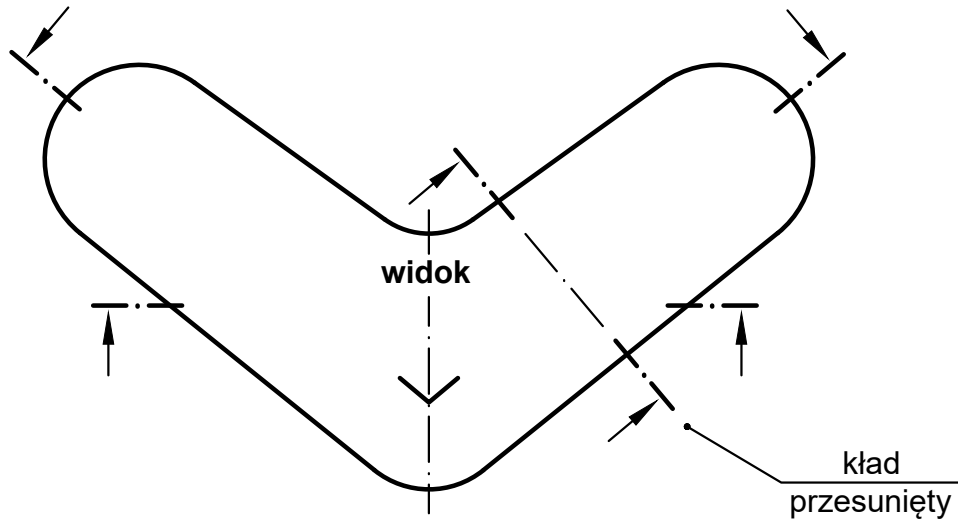
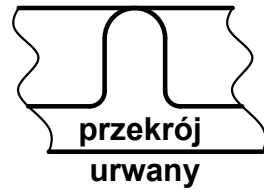

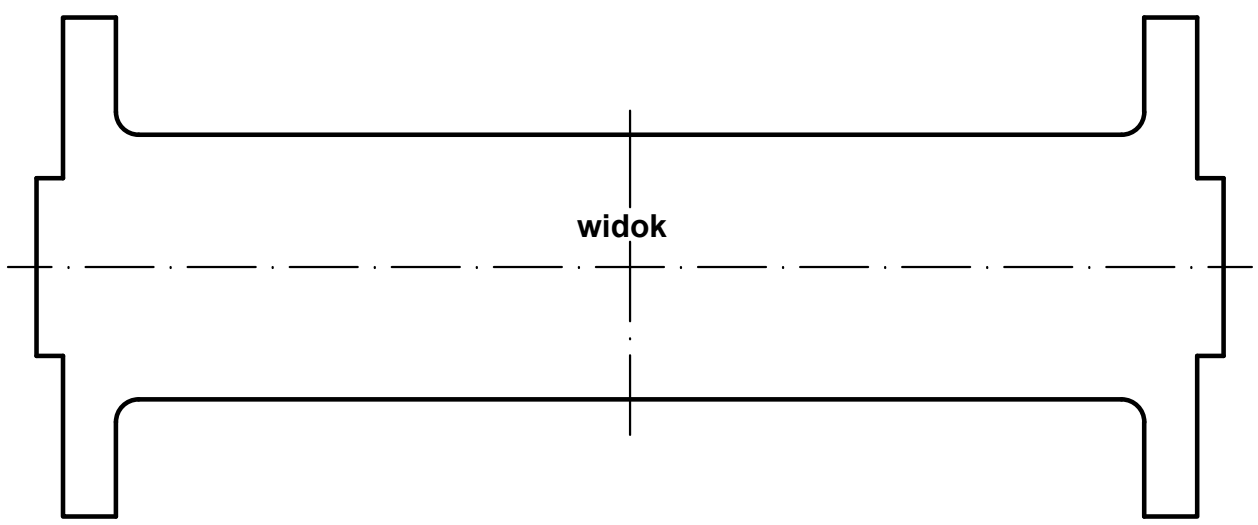
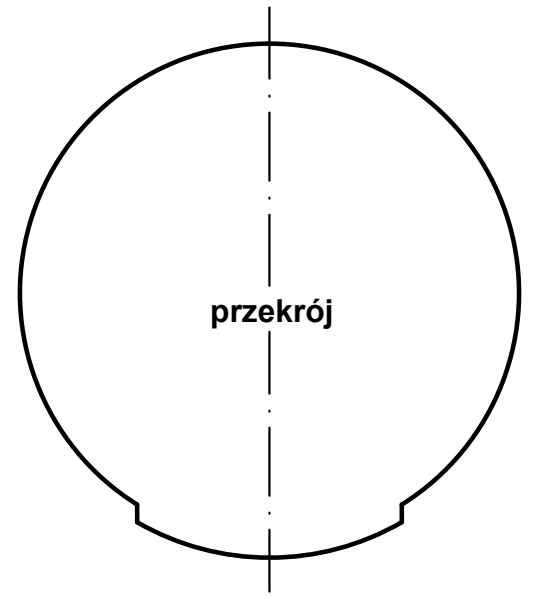
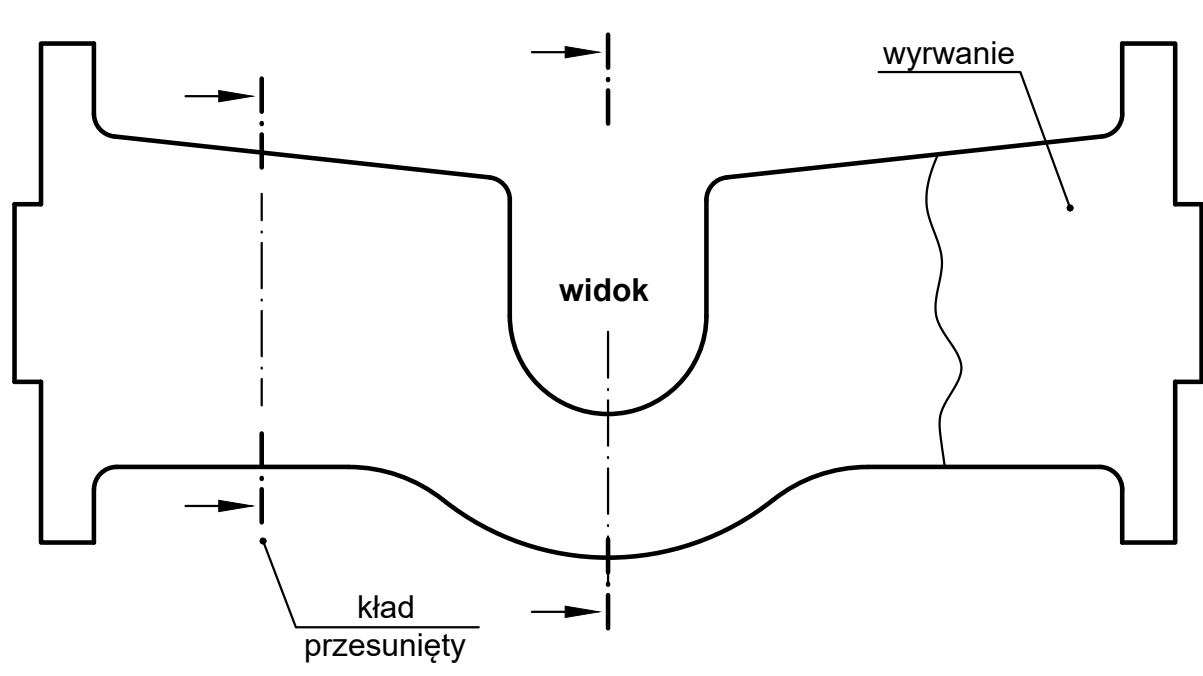

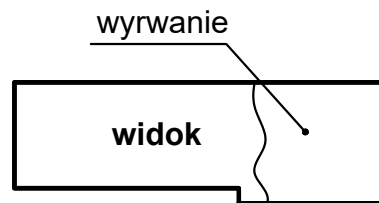
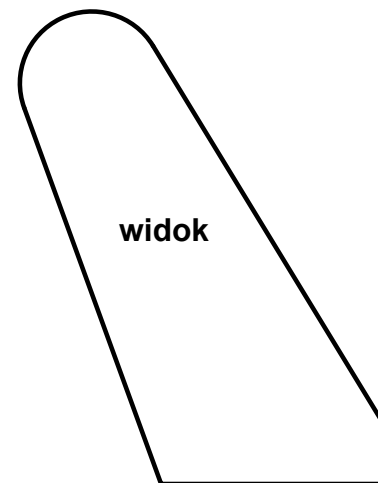
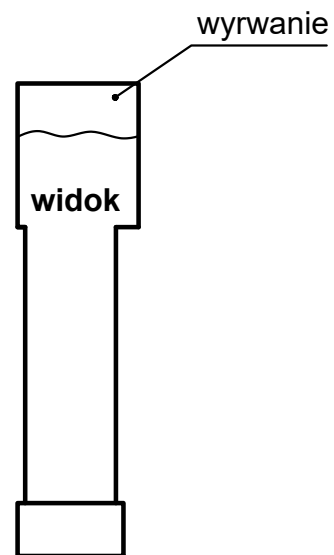
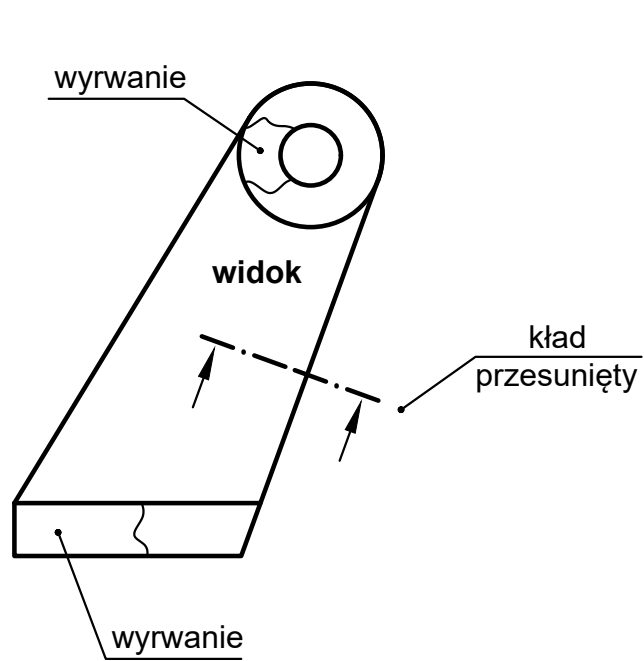

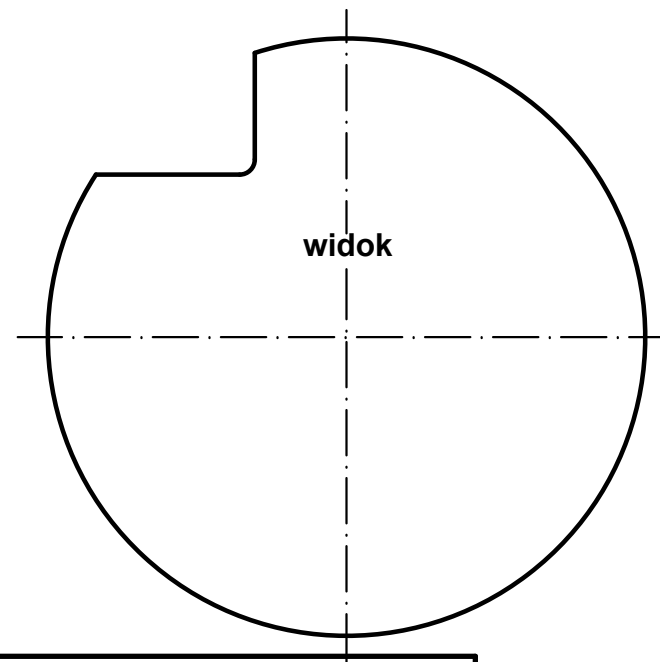
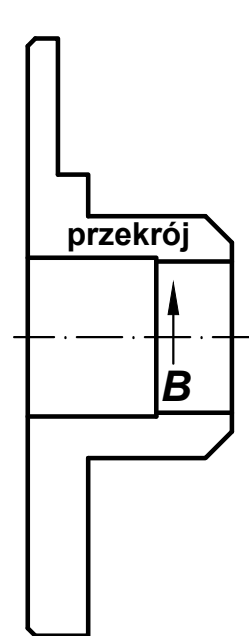
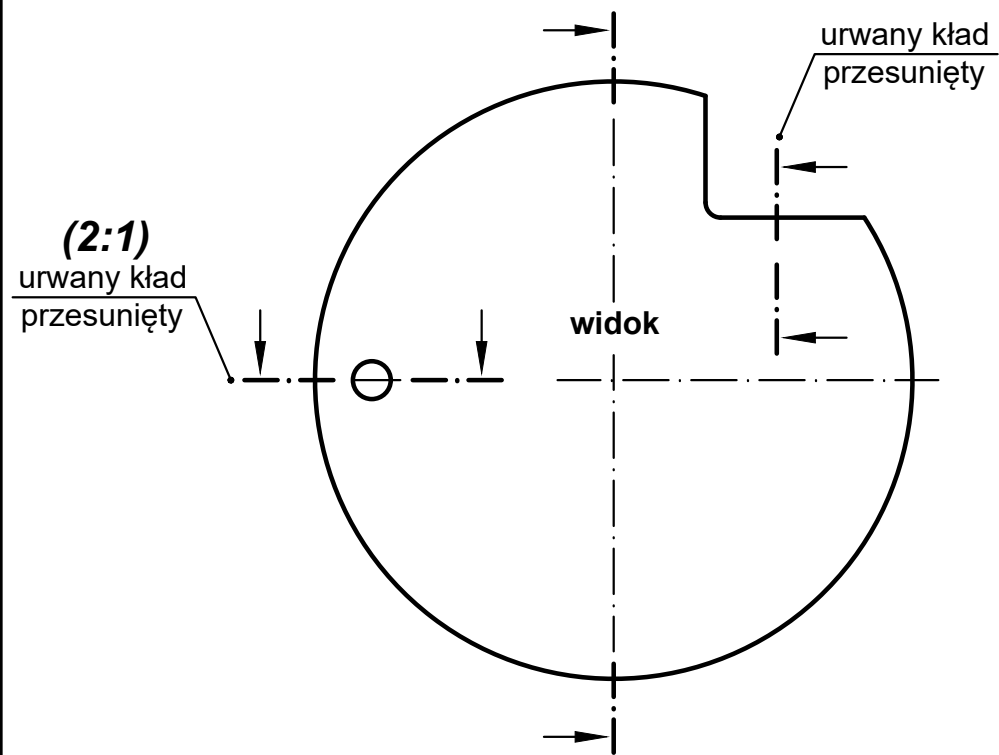

B (2:1)

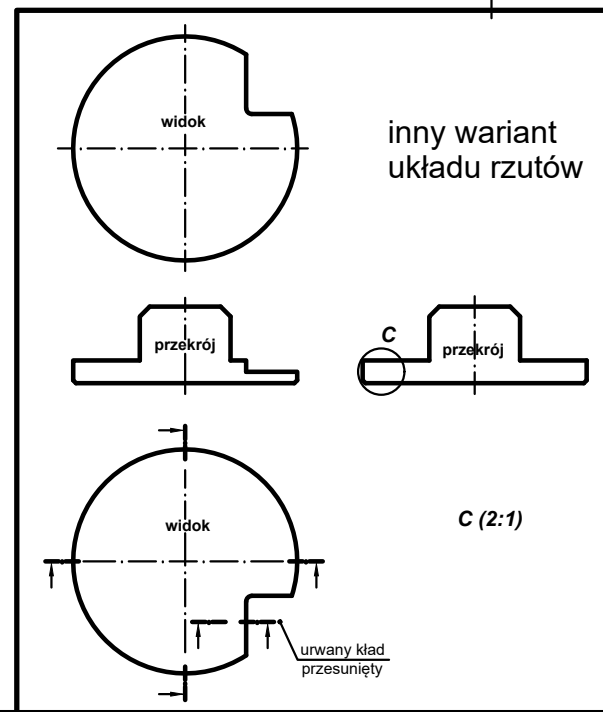

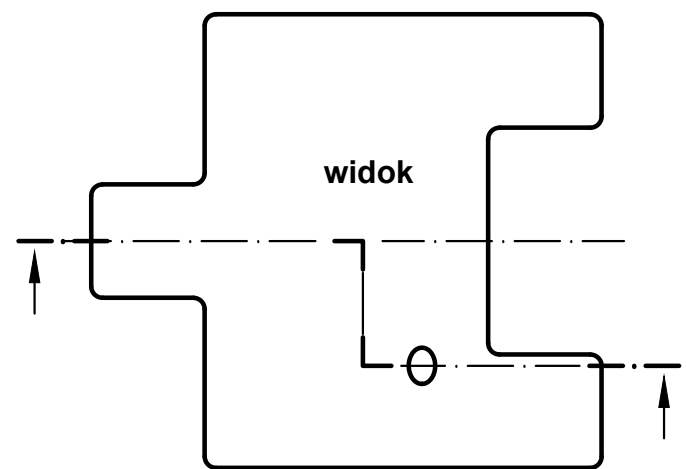
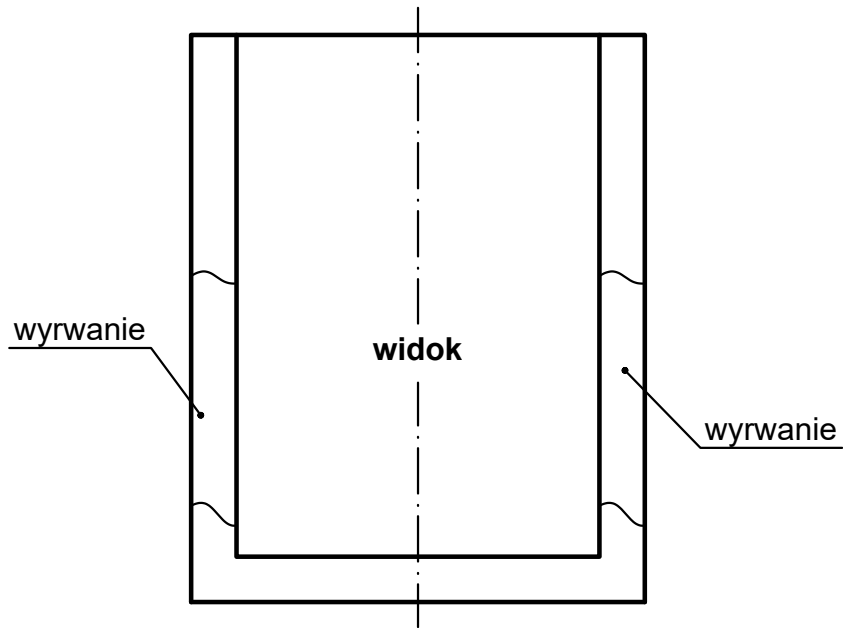
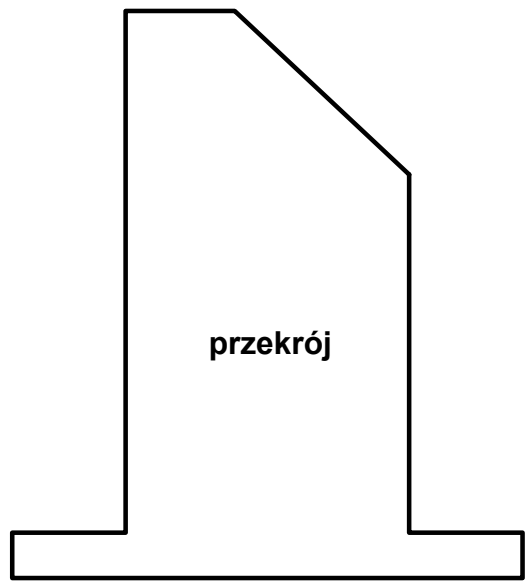

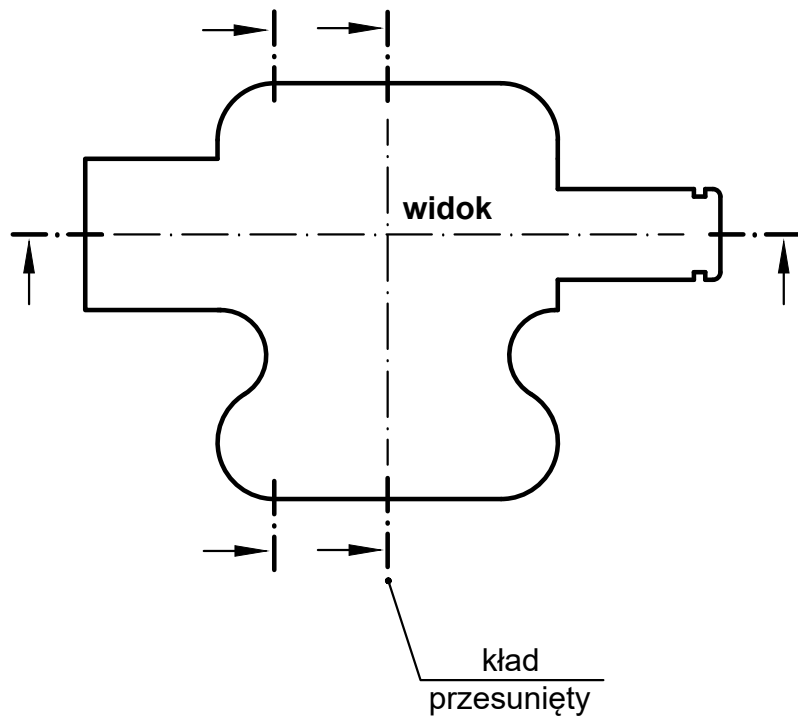
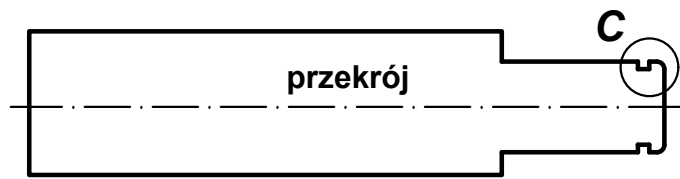

C (5:1)

B (2:1)

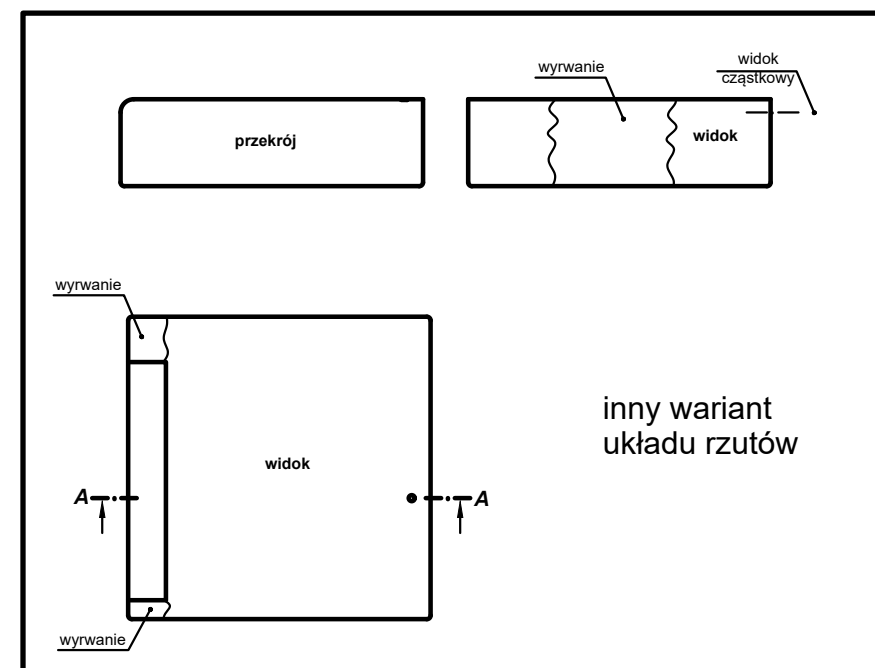
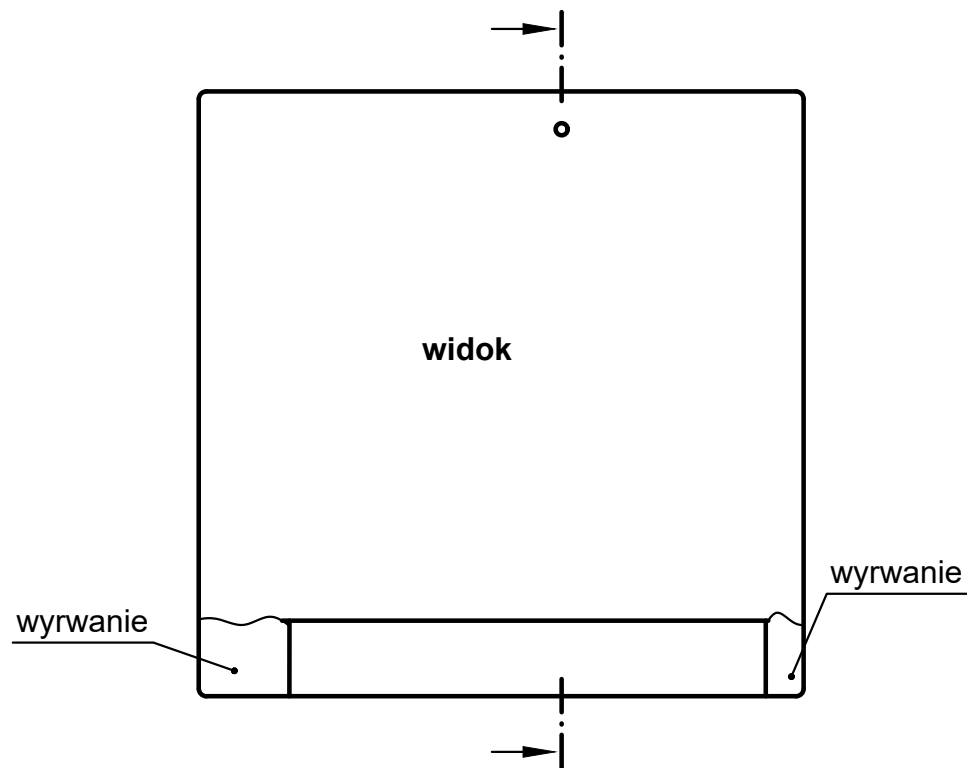
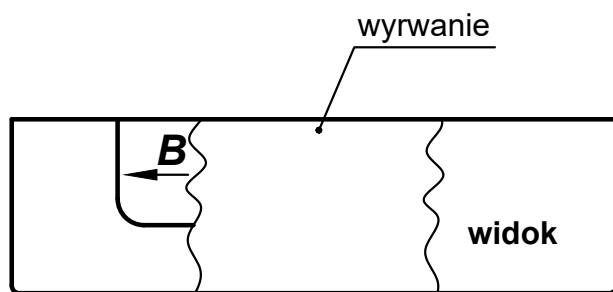

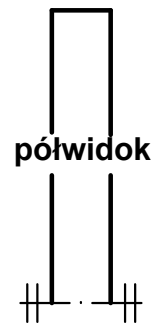

półwidok

B (5:1)

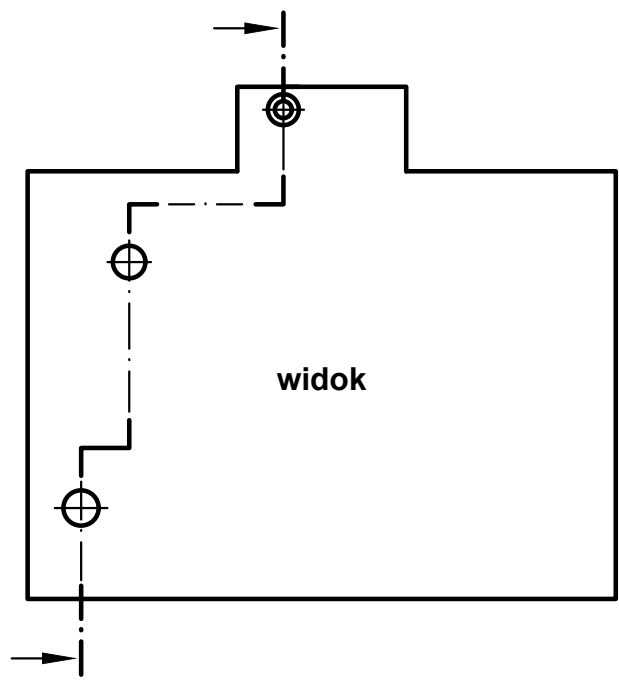

widok



B

przekrój

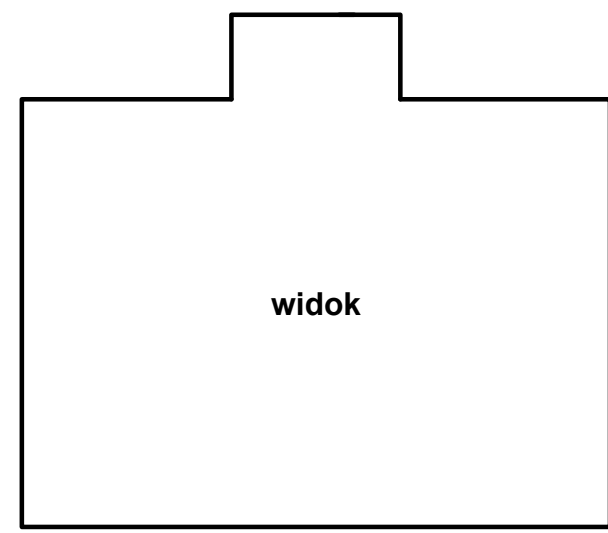

widok

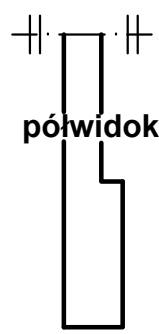

półwidok

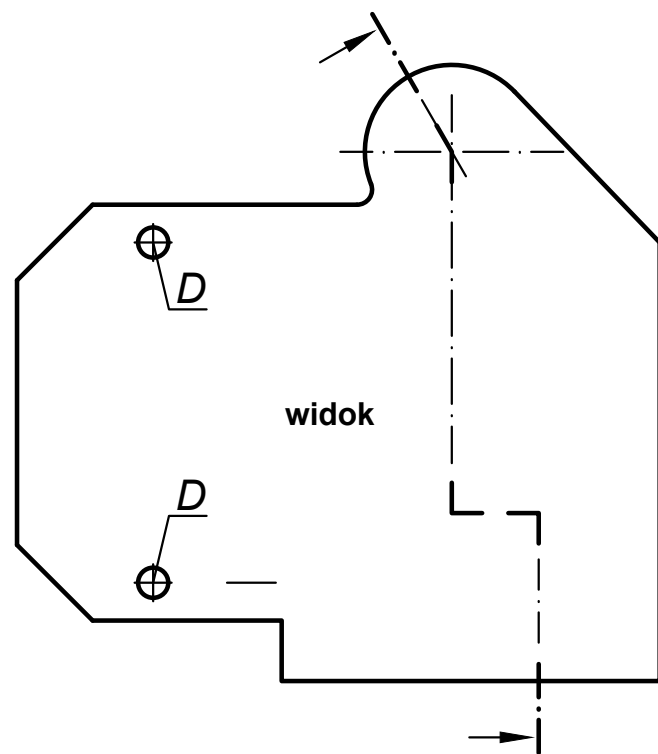
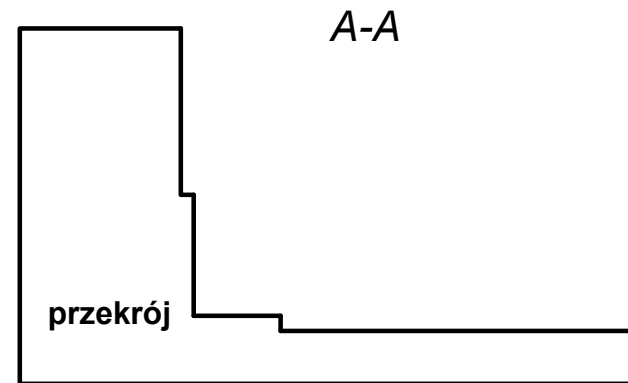
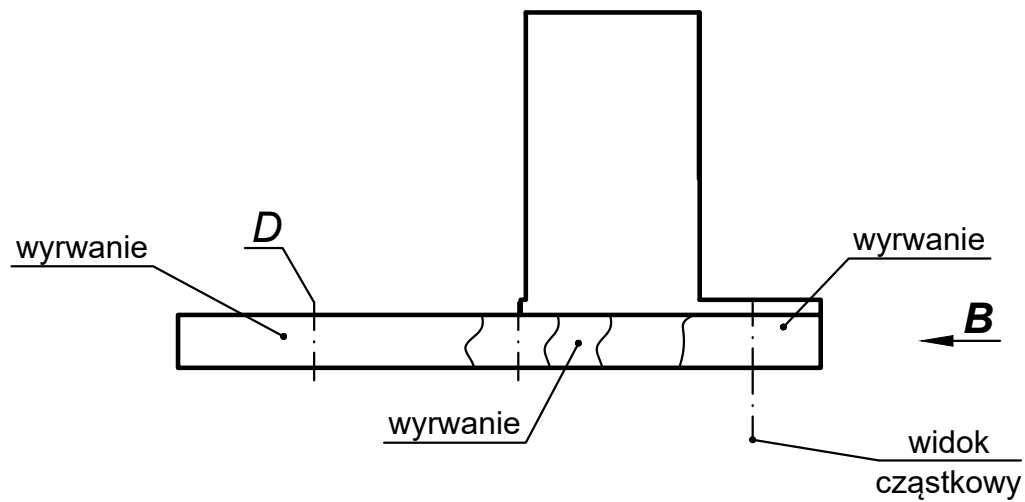

B (2:1)

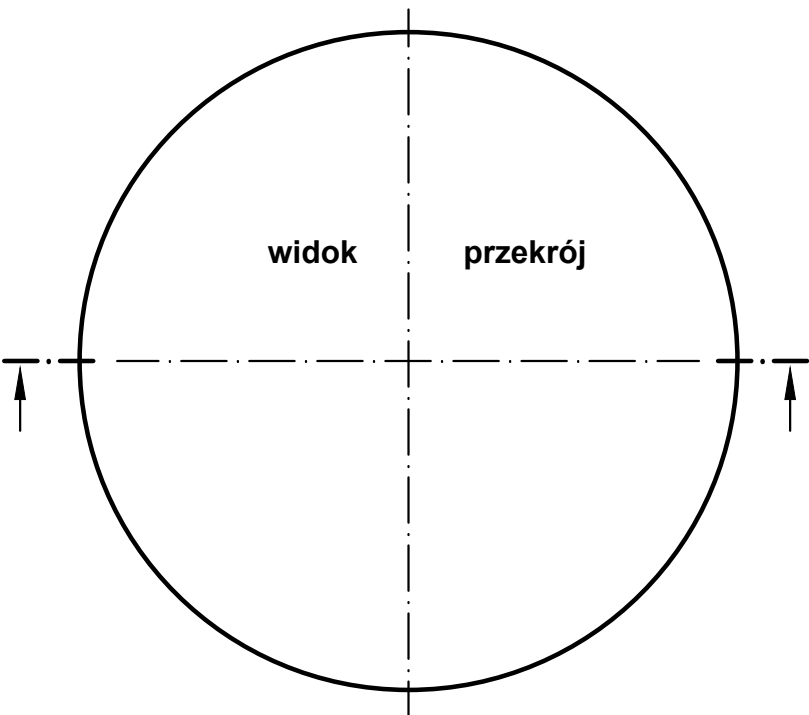
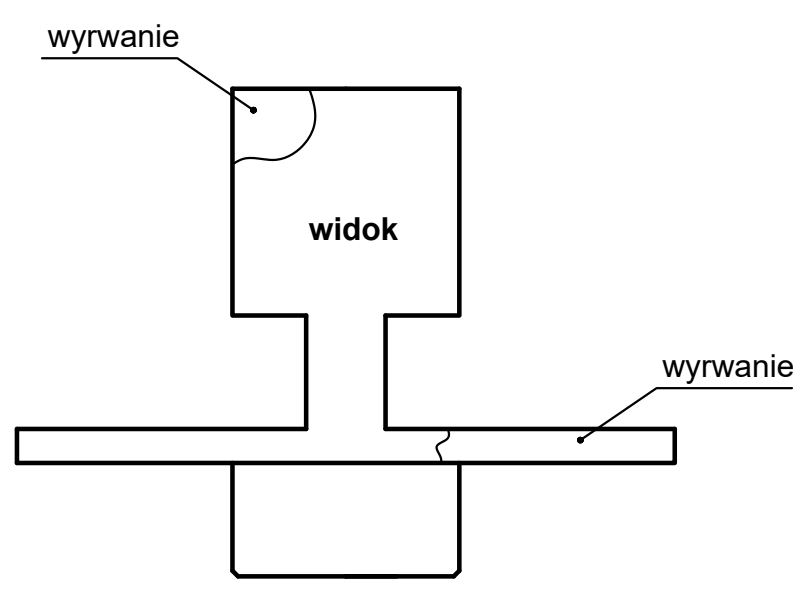
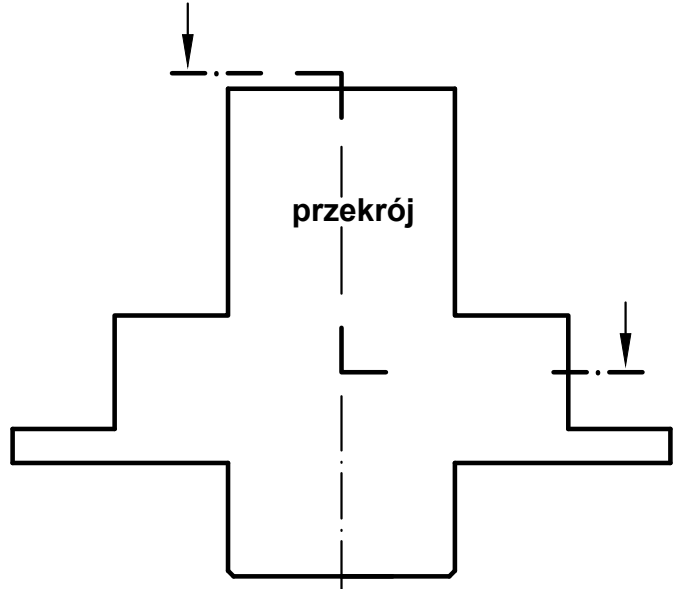

widok

przekrój

widok

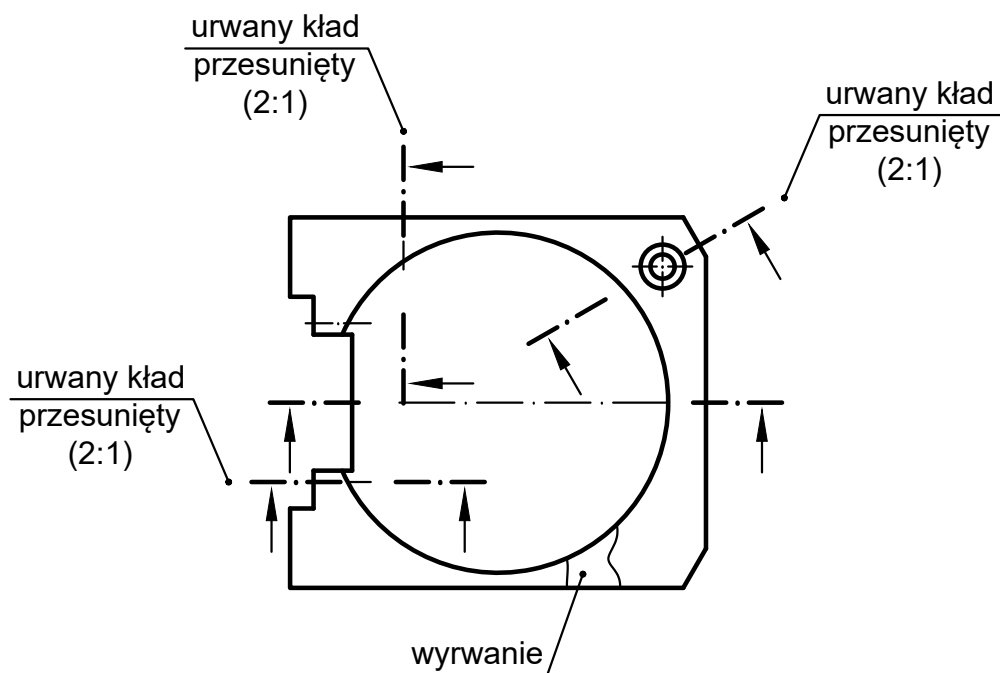

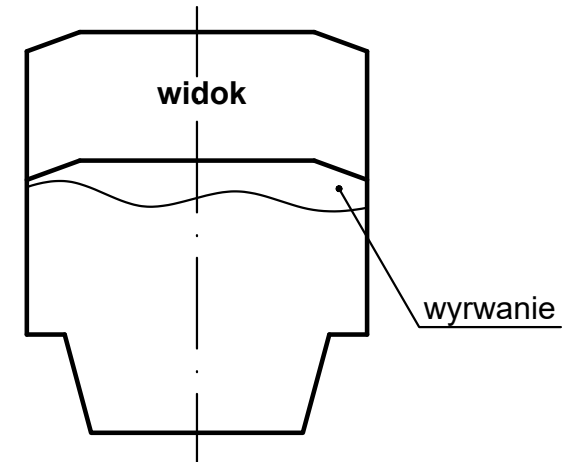
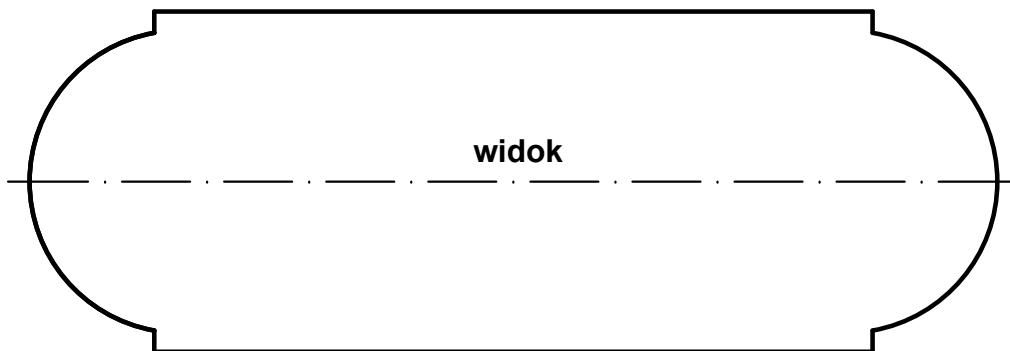
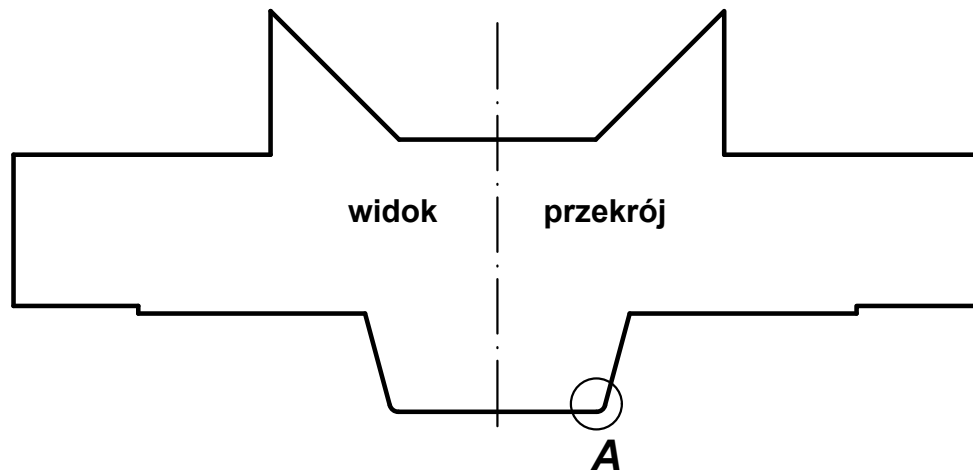

A (5:1)

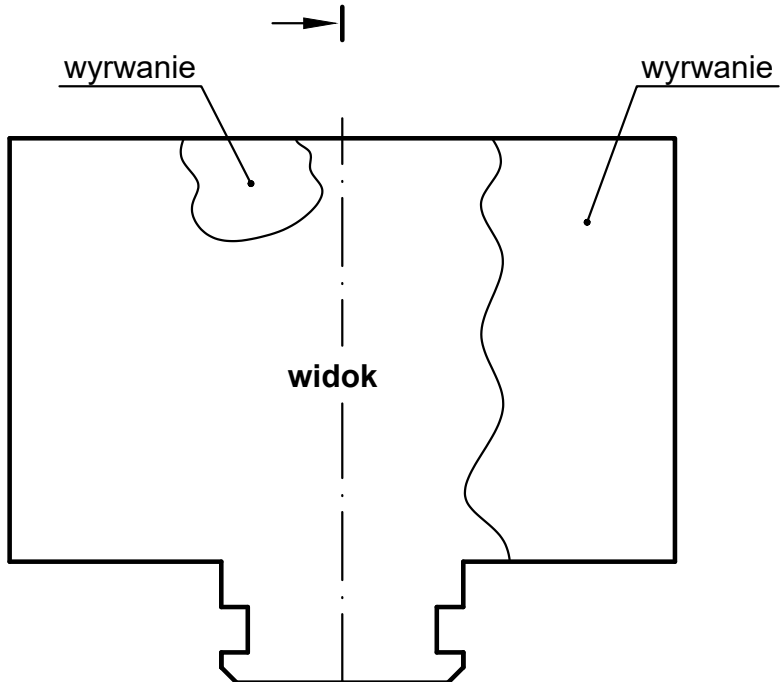
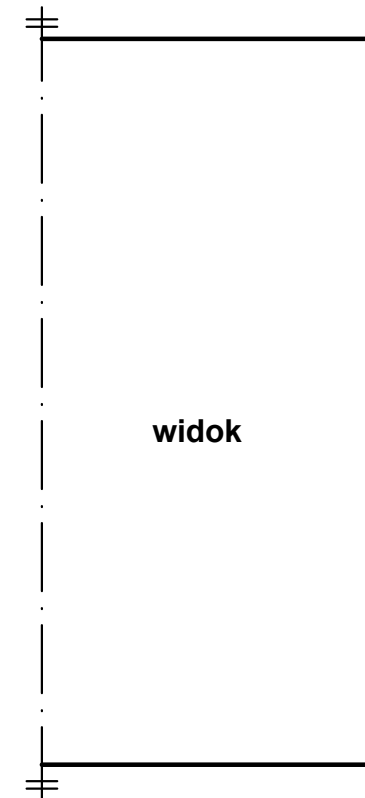
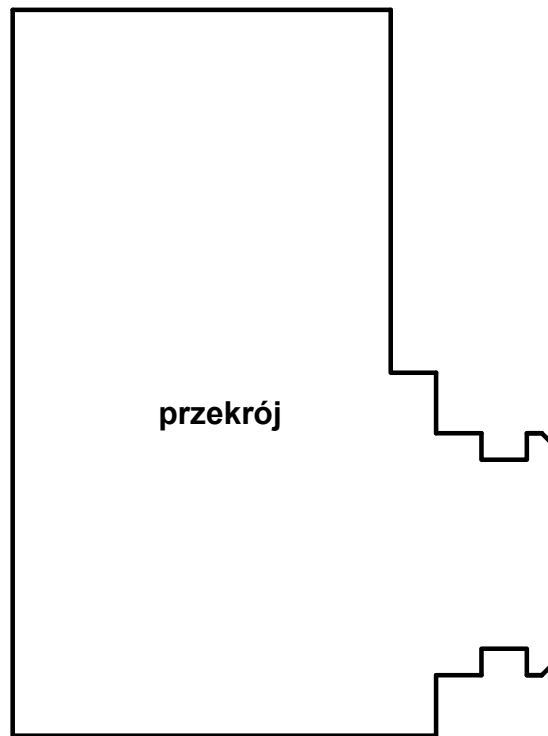
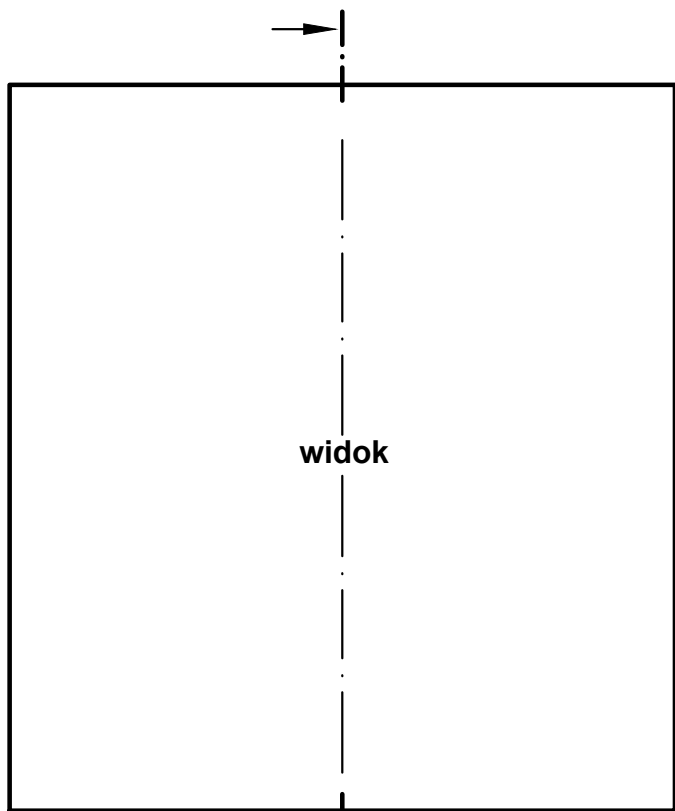

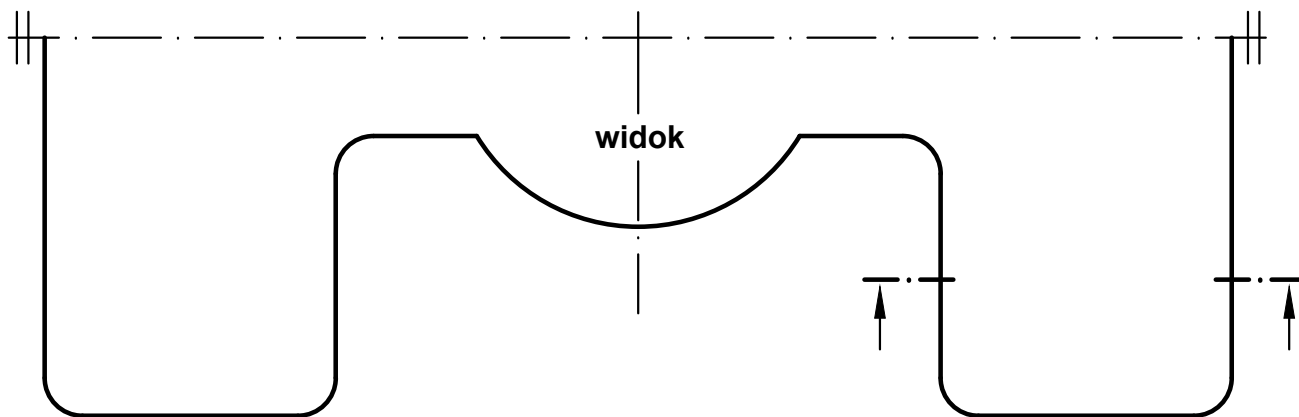
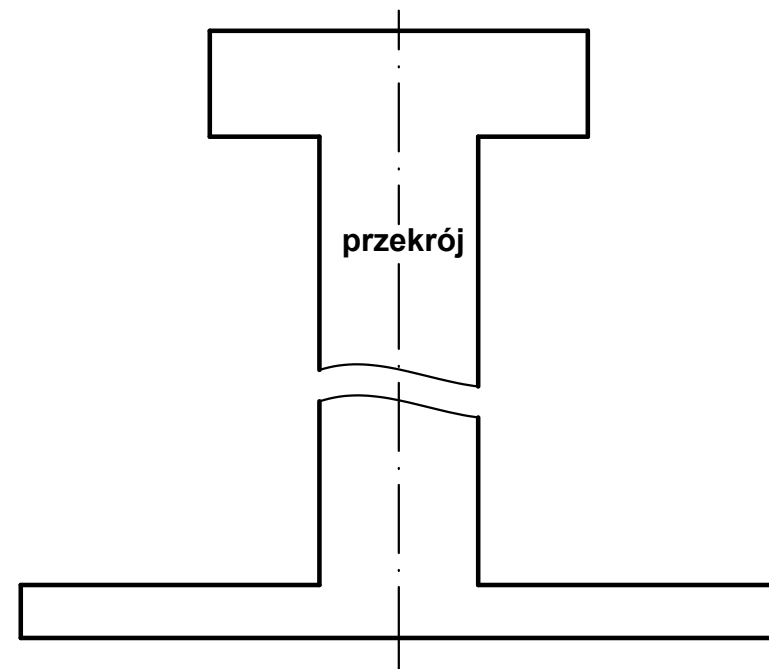
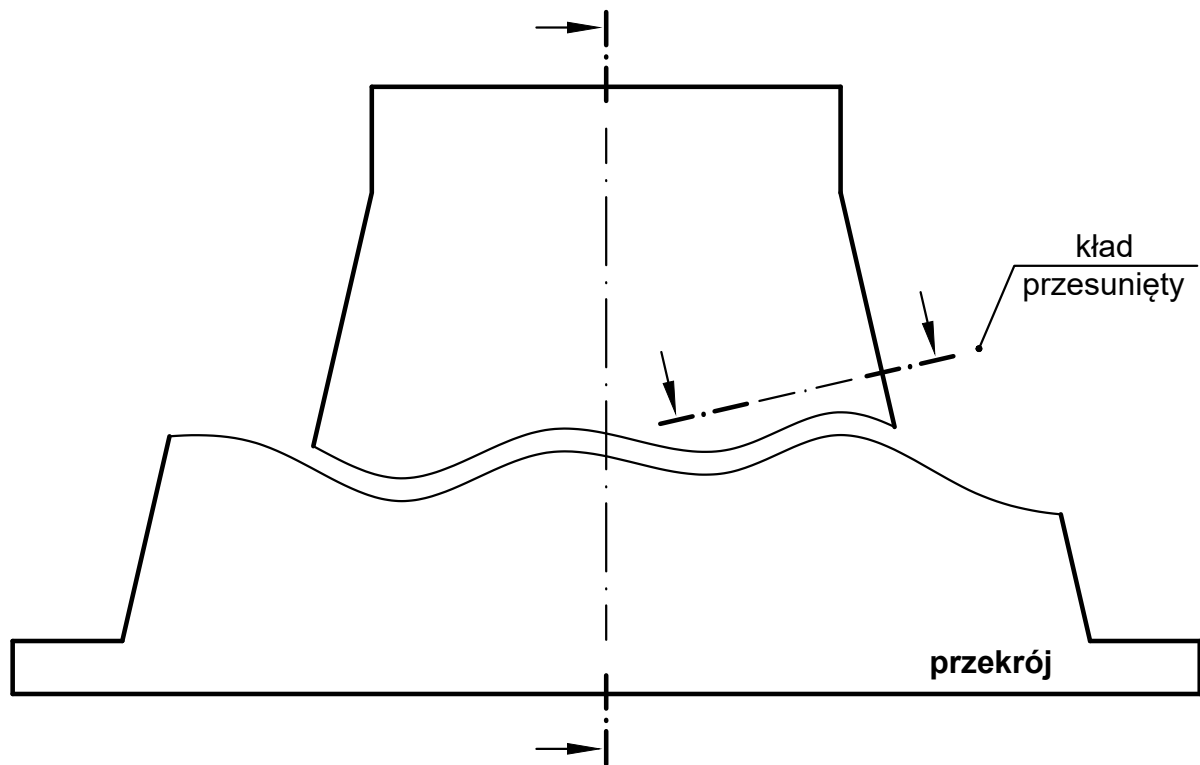

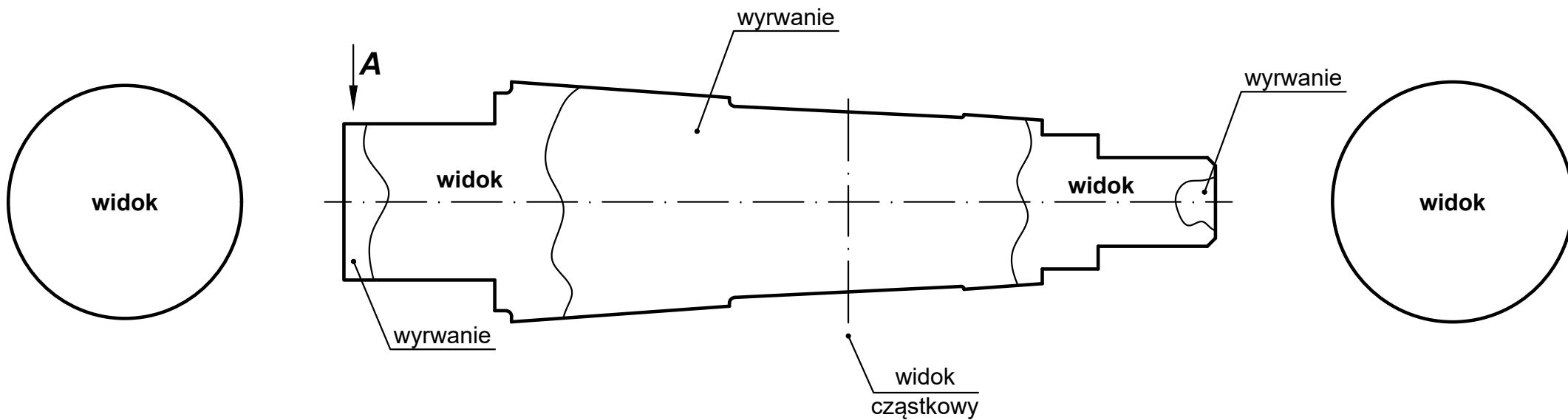

A (5:1)

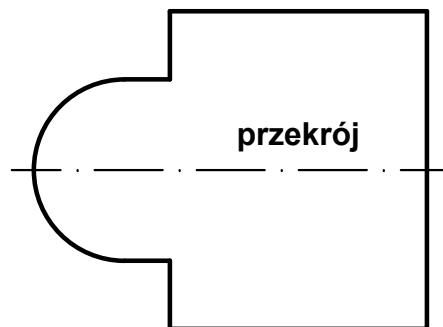
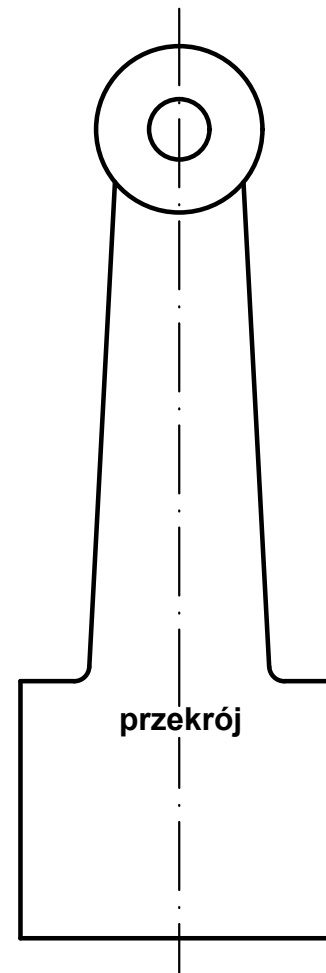
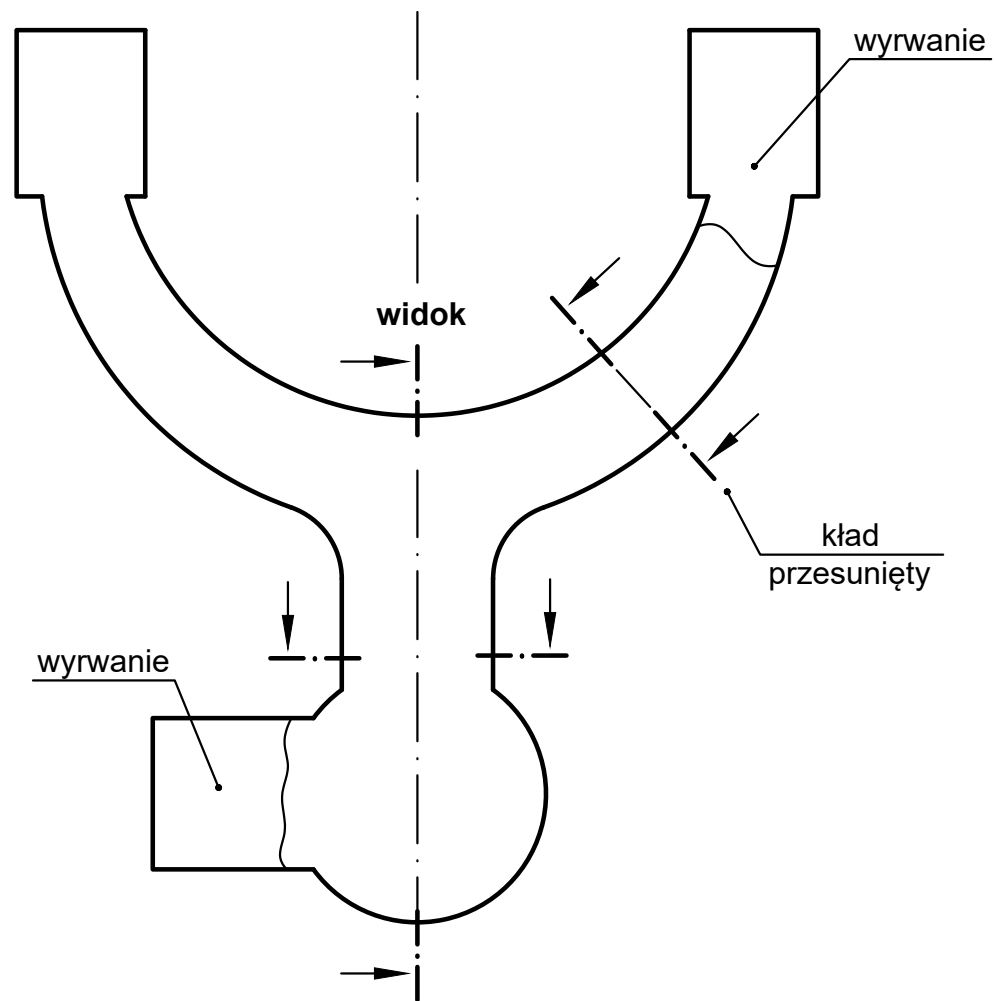

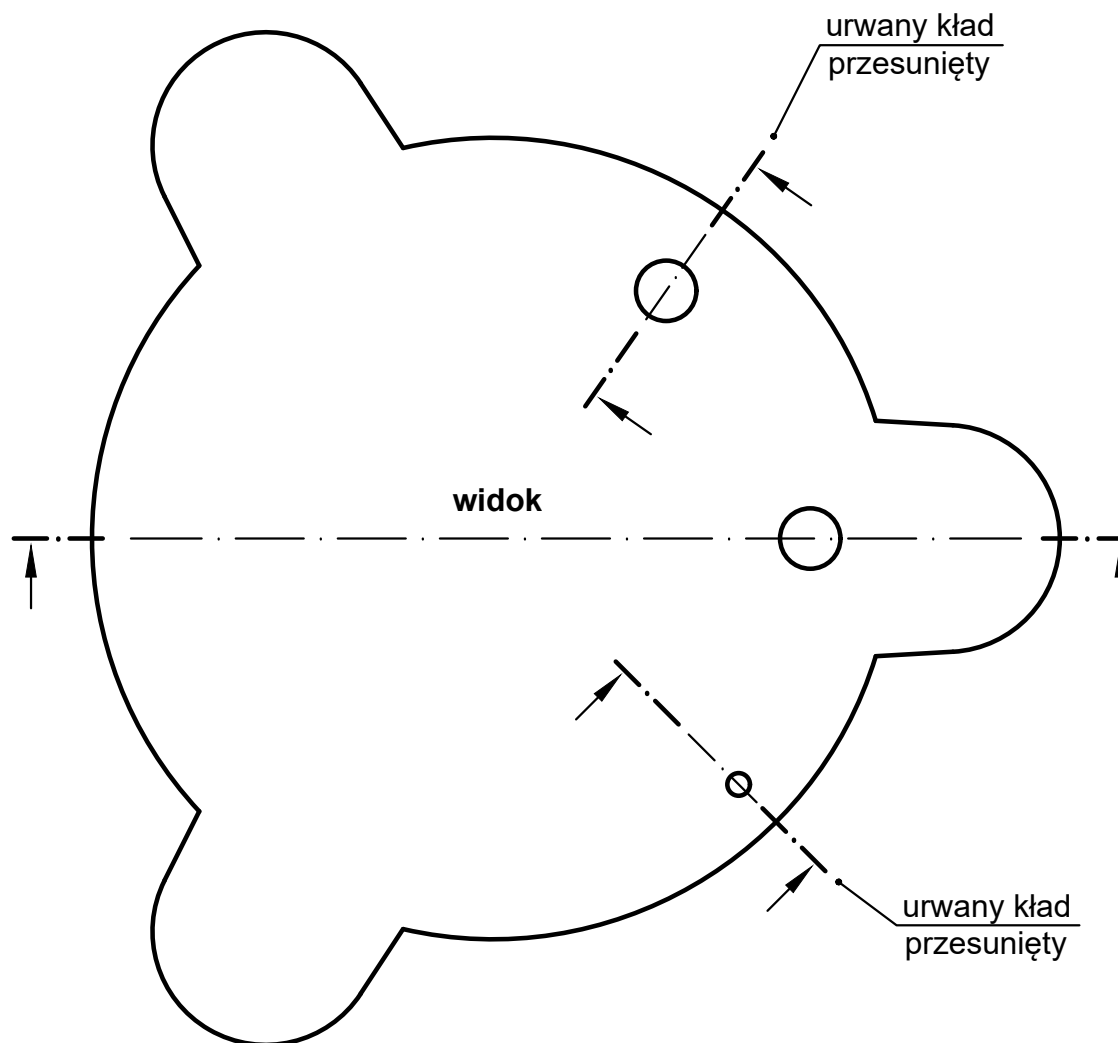
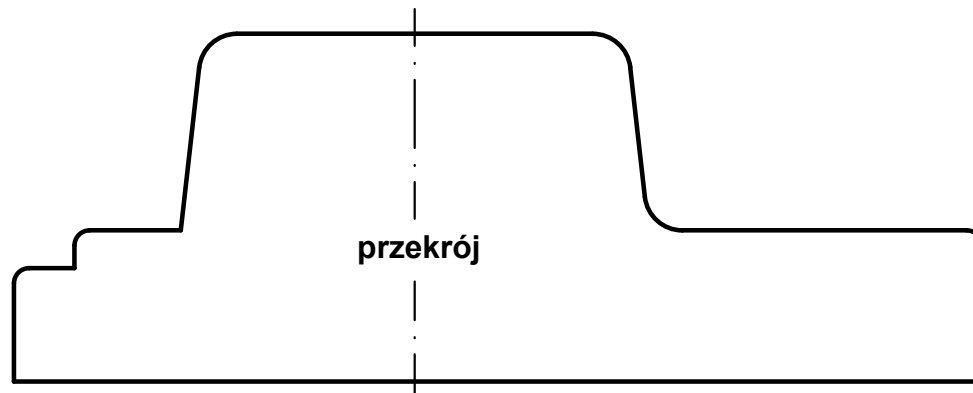

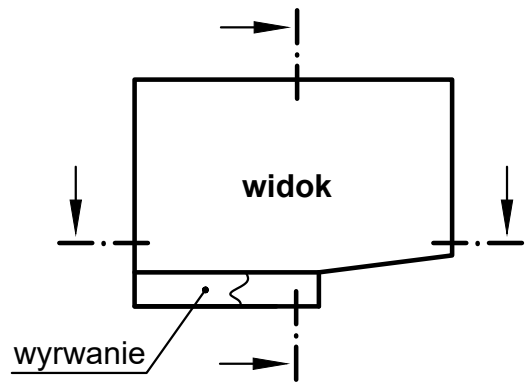
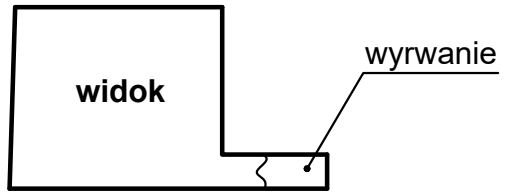

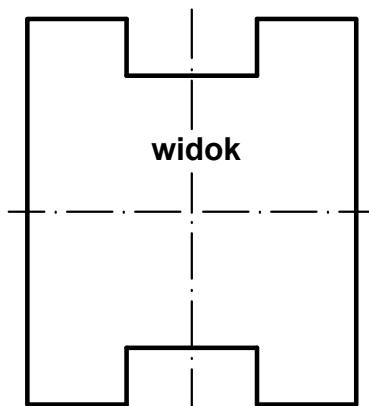
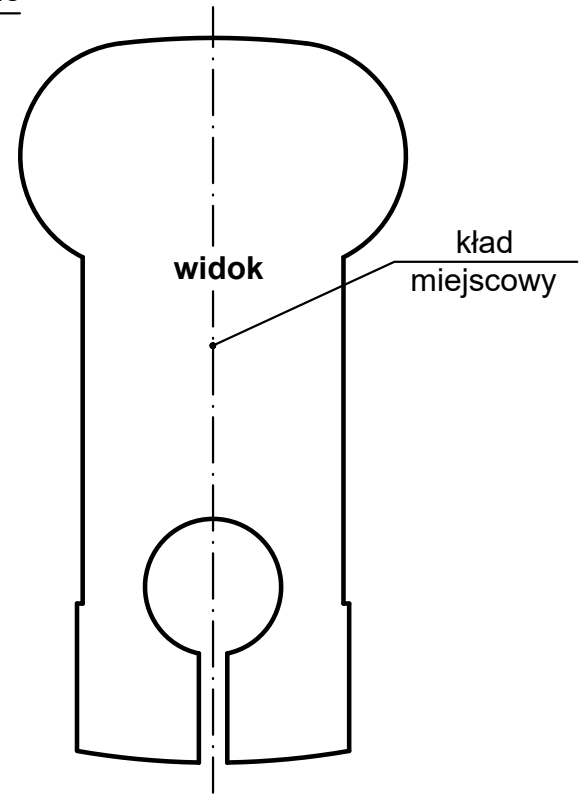
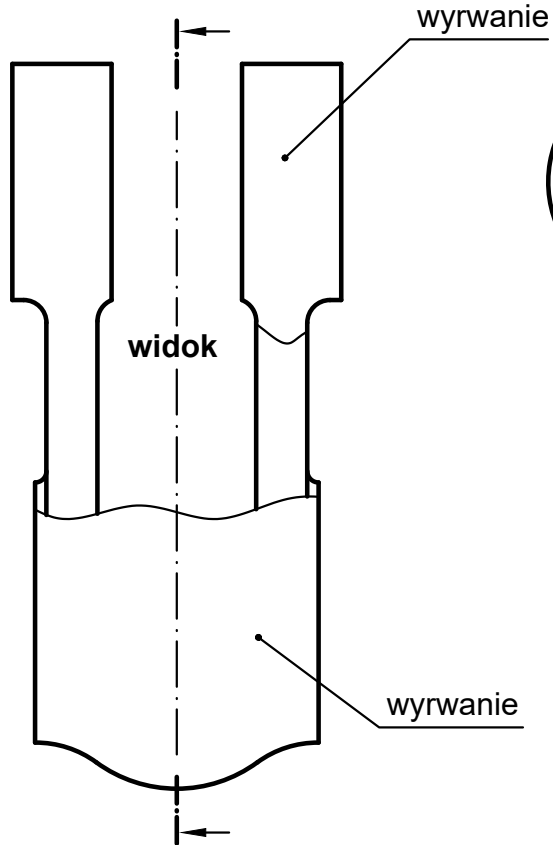
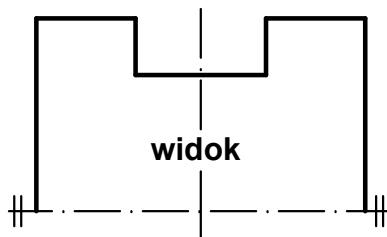
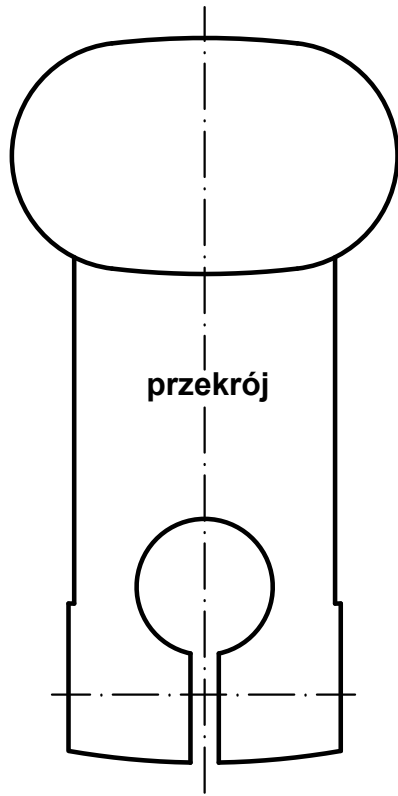

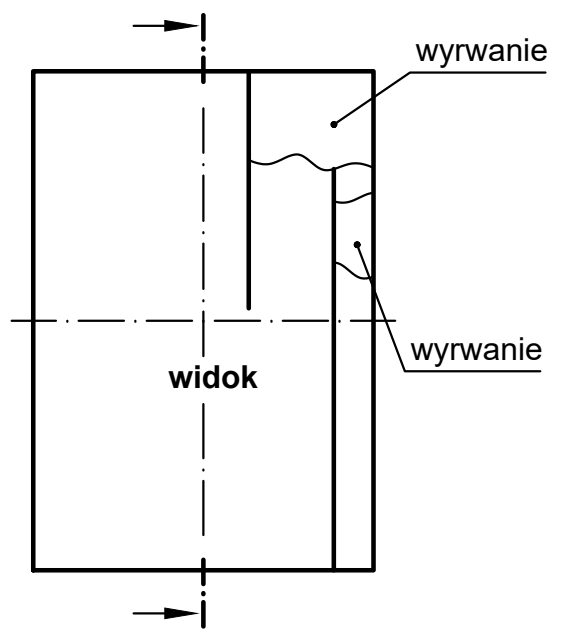
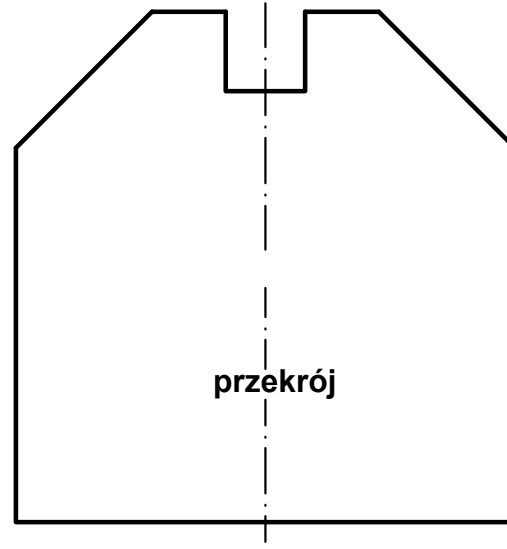
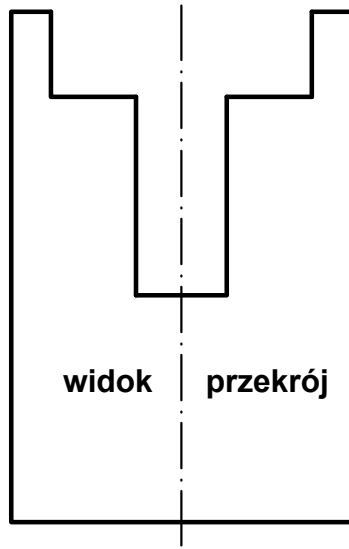

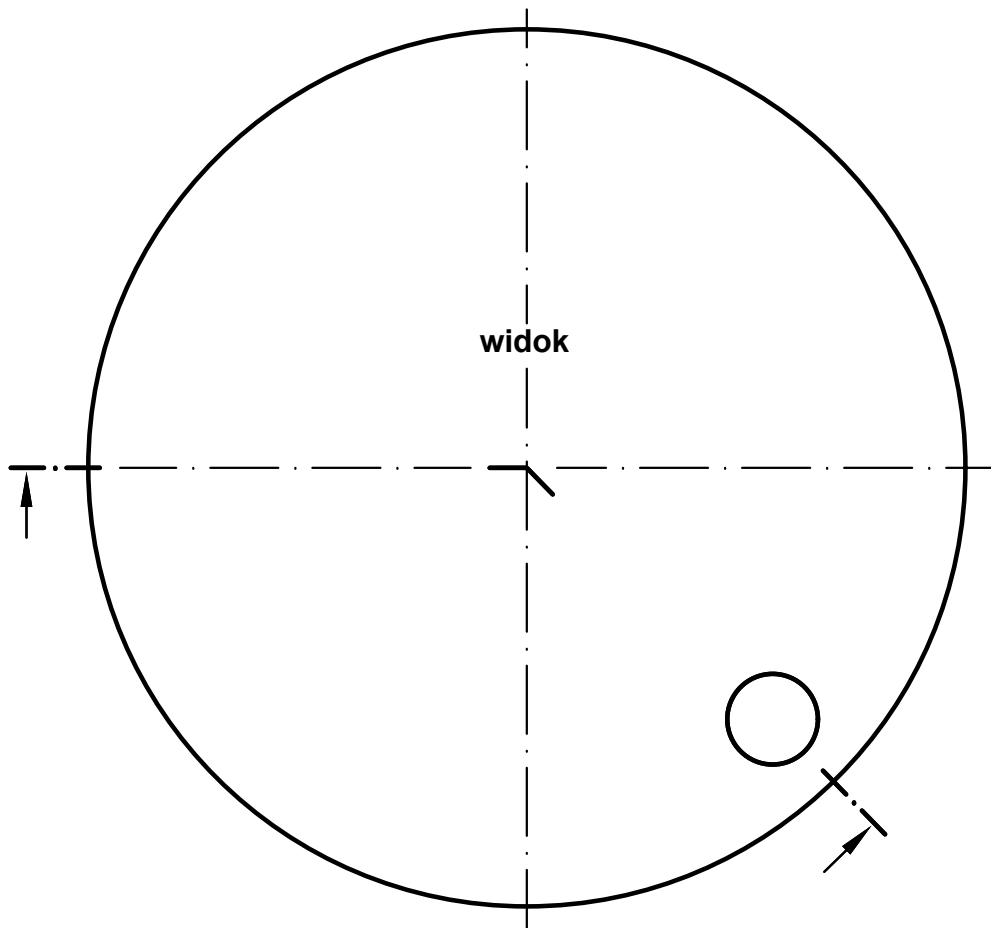
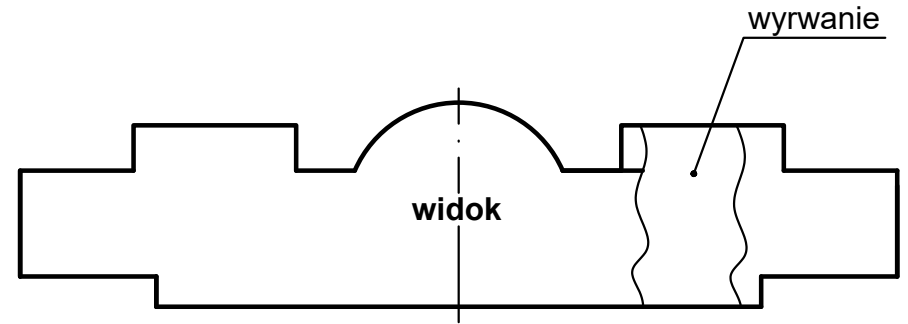
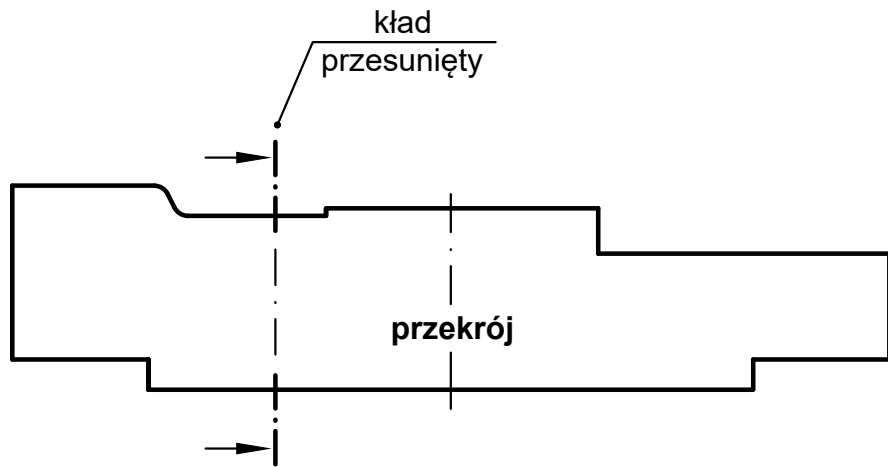

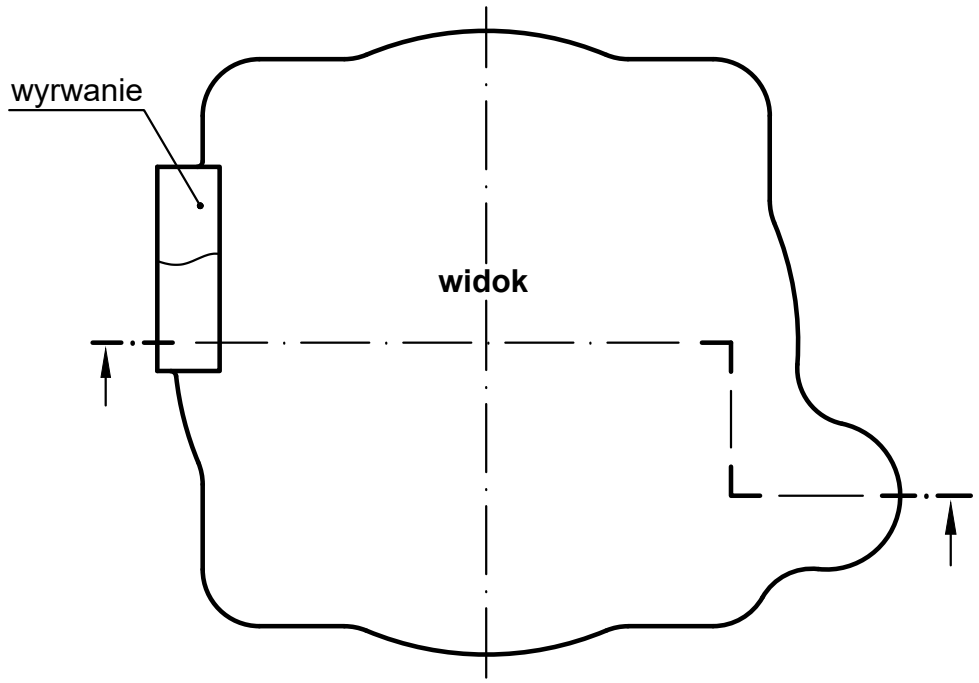
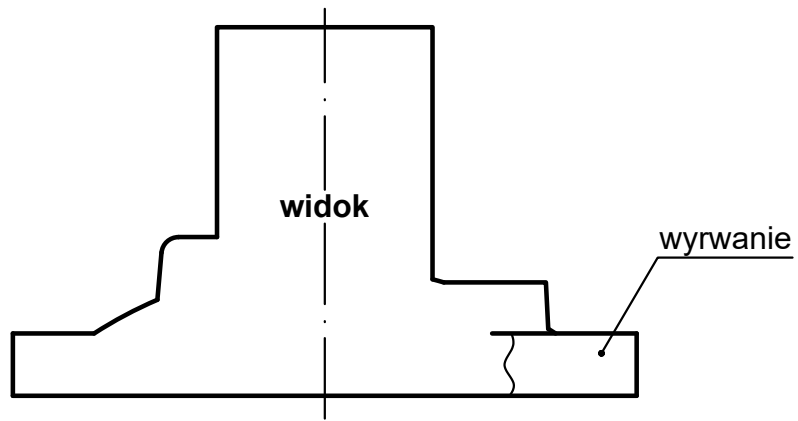
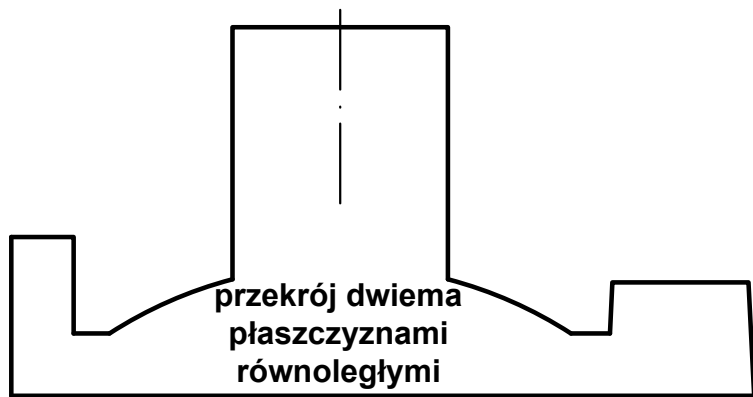

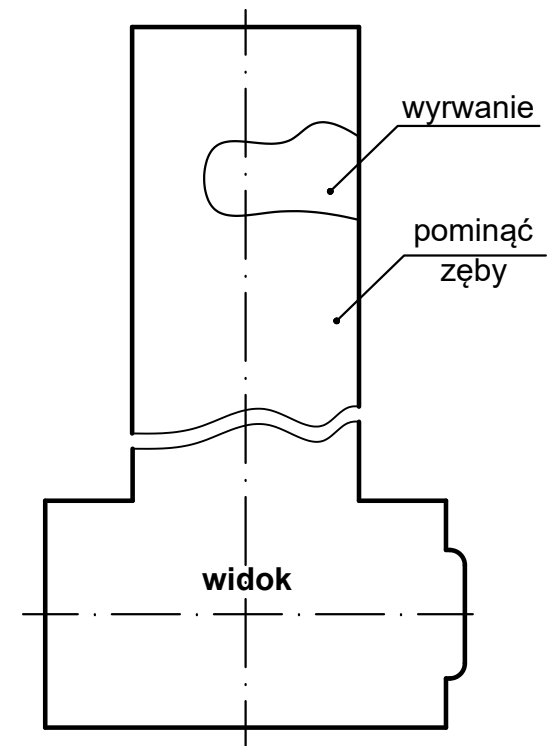
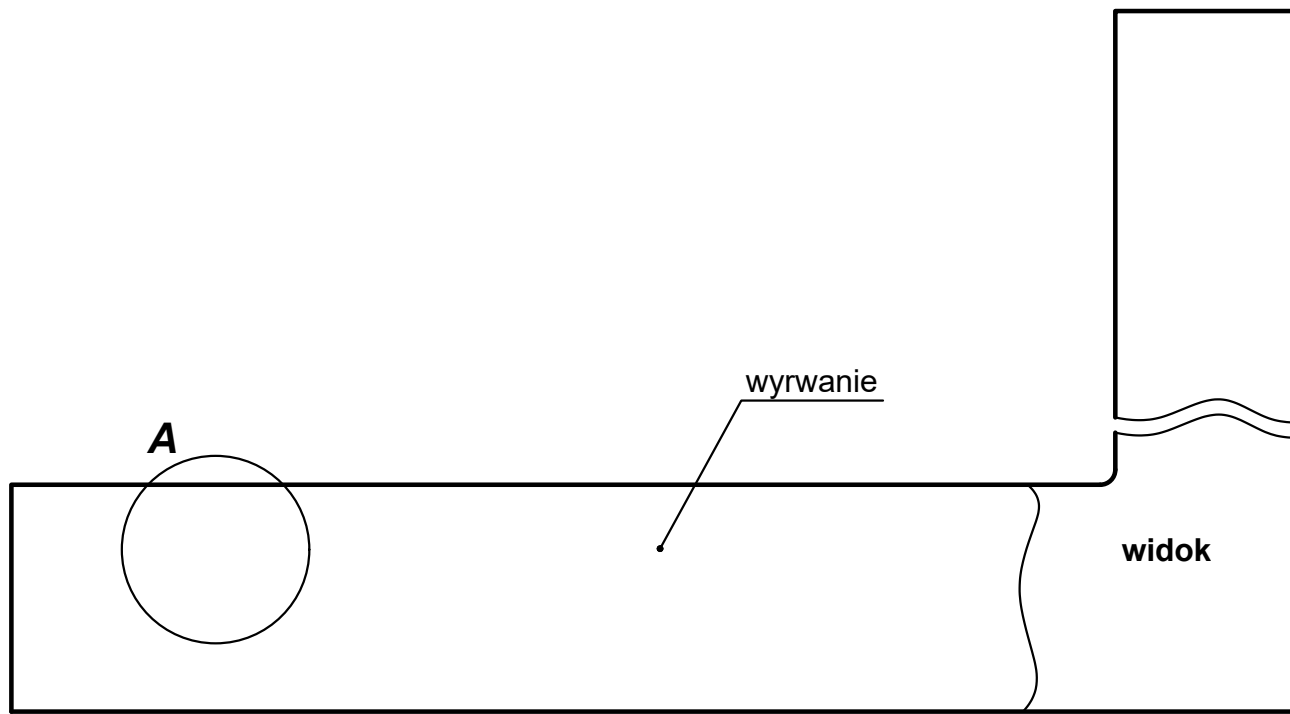

A (2:1)

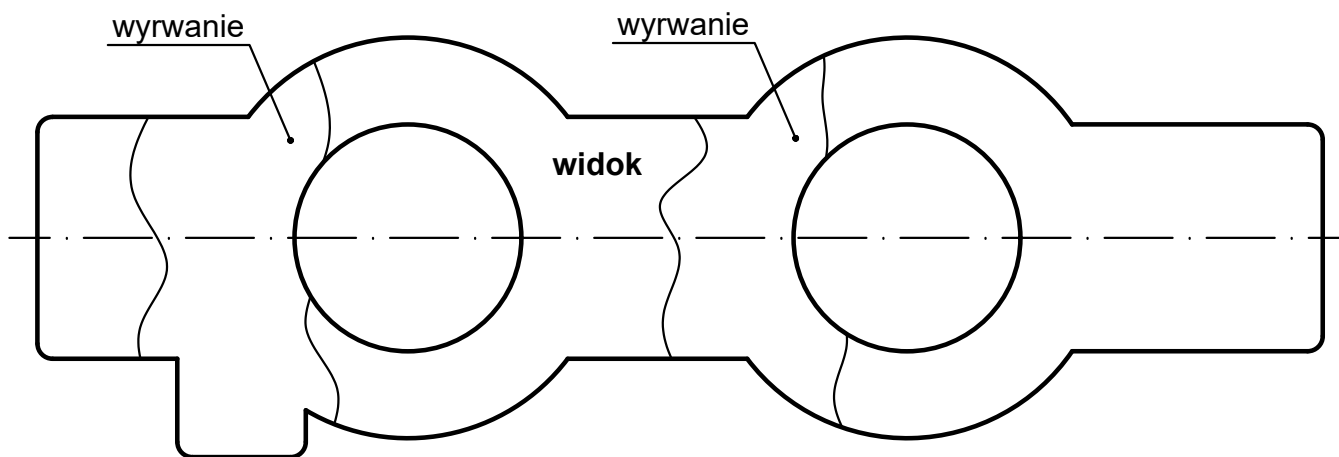

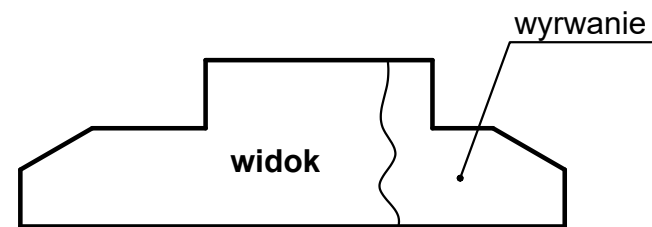
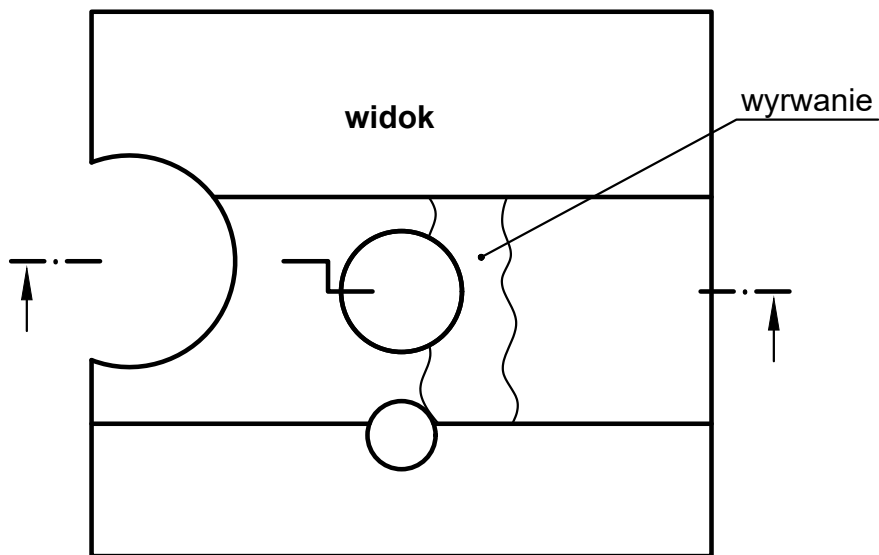
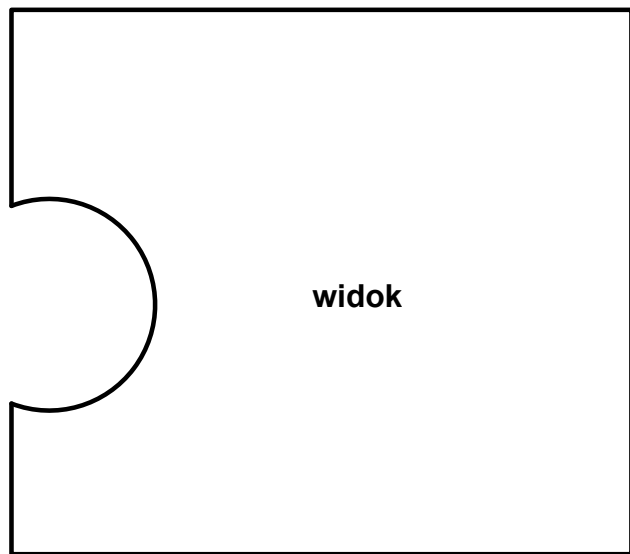

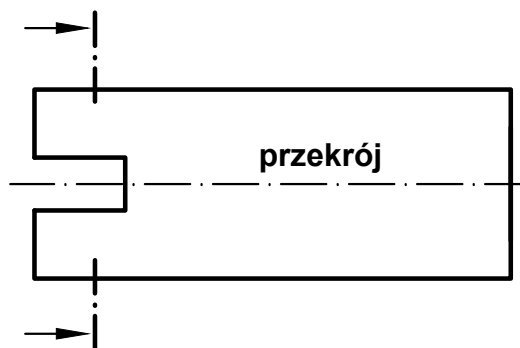
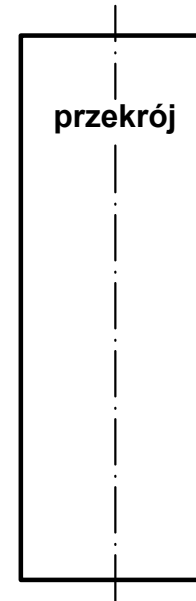
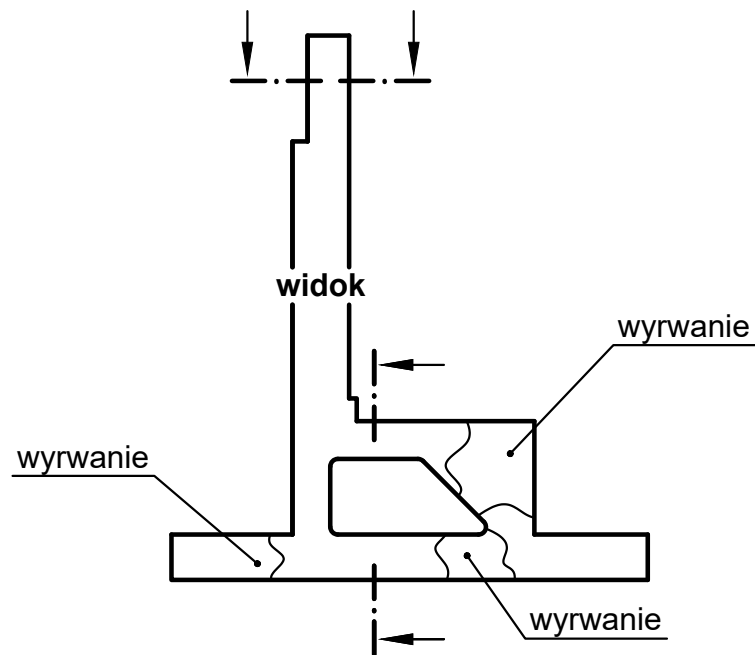
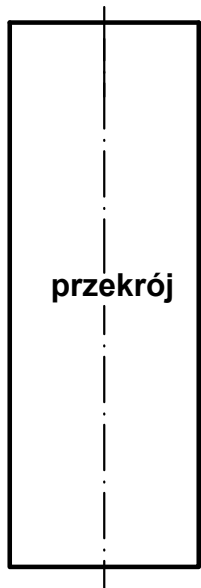

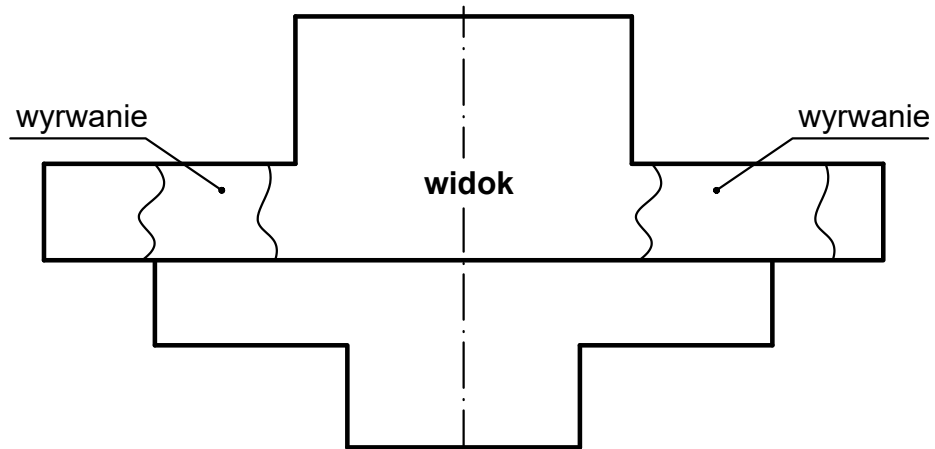
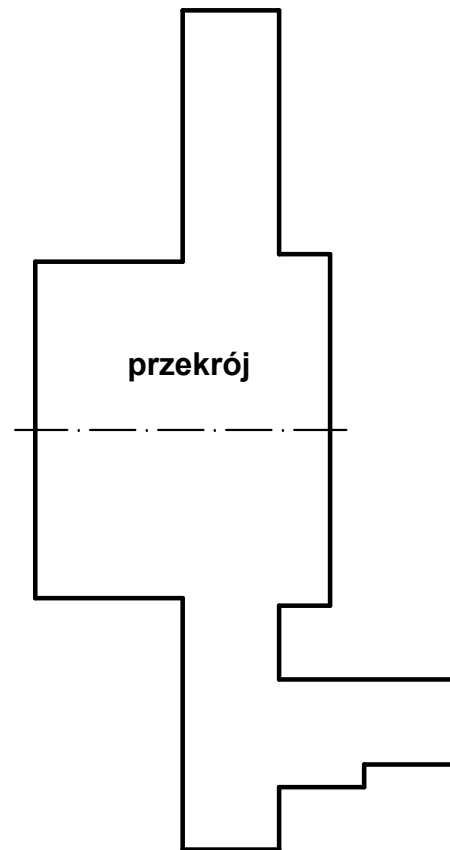
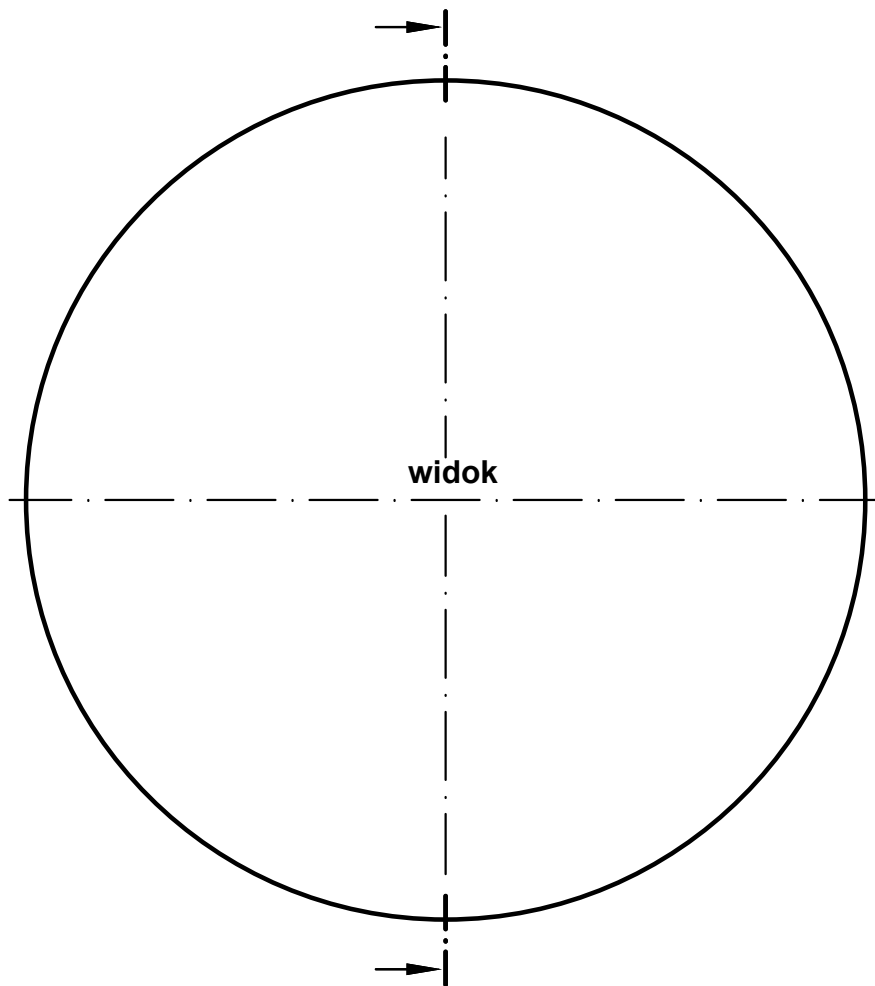

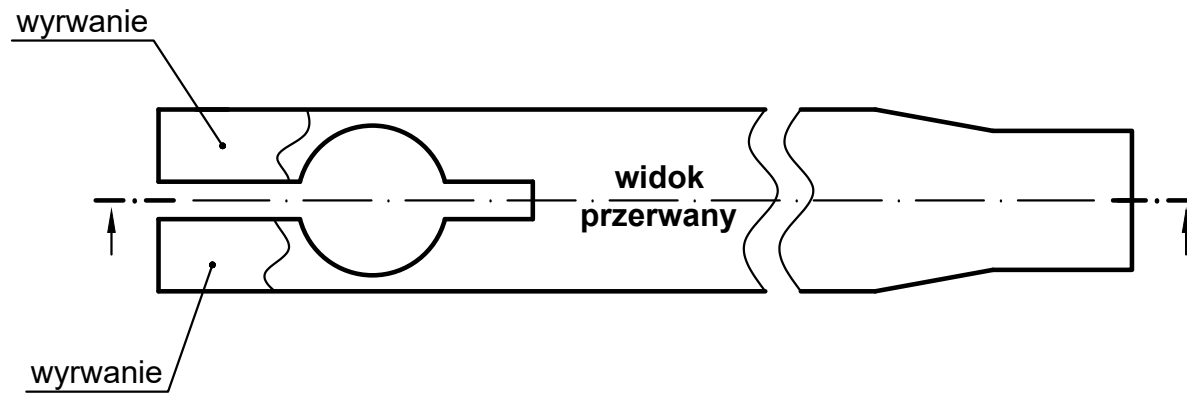
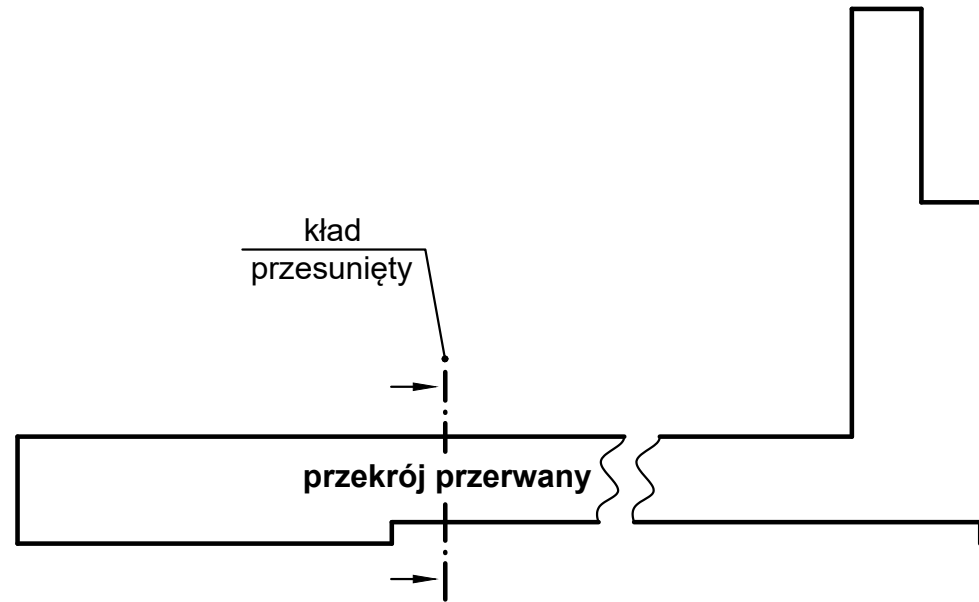
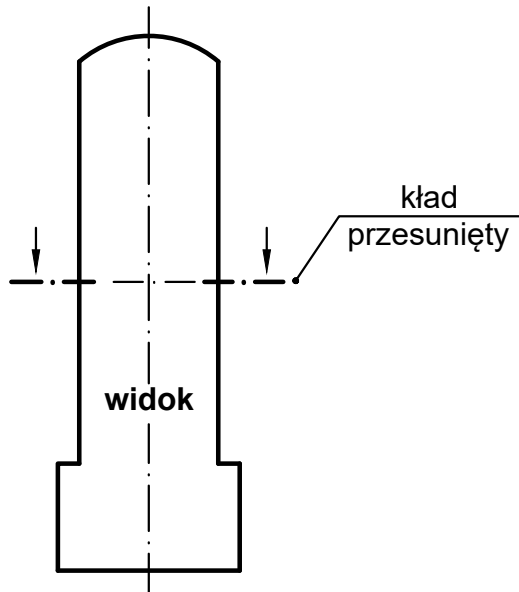
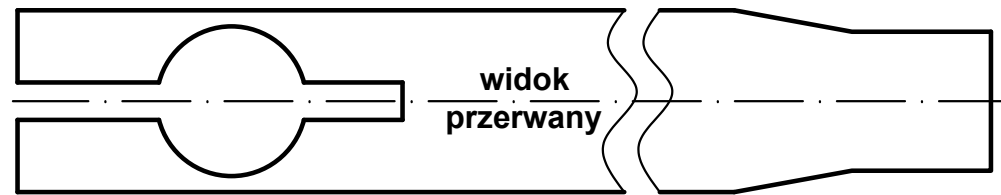

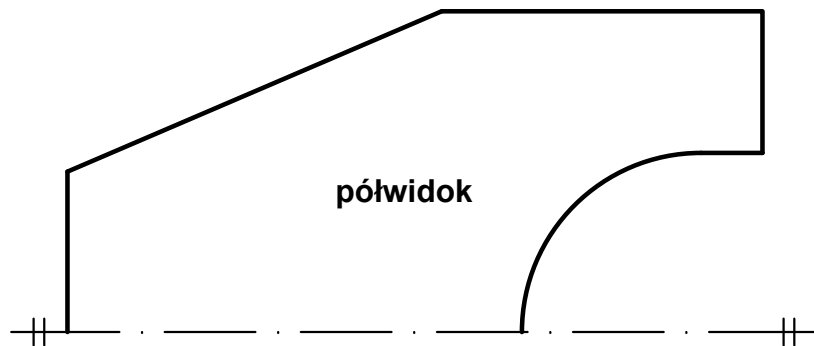

B (5:1)

